



**RAM**

2020 RAM 1500



THIS IS WHAT WORKS:  
LUXURY, TECHNOLOGY, CAPABILITY AND STRENGTH.



**WORKHORSE ATTITUDE. THE LINES OF A WINNING THOROUGHbred.** More than ever, a Ram 1500 is tasked with multiple assignments. Fortunately, this full-size pickup is designed to accomplish nearly every towing and hauling assignment you'd expect. This rolling powerhouse delivers, from

sophisticated technology like the largest available touchscreen media center<sup>1\*</sup> to best-in-class rear leg room<sup>1</sup> and largest brakes in its class<sup>1</sup>—and that's just to start. From the basic values of Tradesman<sup>®</sup> to the craftsmanship of Limited, this is one pickup focused on finishing first. This is Ram 1500.

\*All disclosures can be found on the last page.





LUXURY. IT'S JUST NATURAL.

THE CONVERGENCE OF AVAILABLE LEATHER TRIM AND REAL WOOD.



# EXCEPTIONAL COMFORT

IT'S ALL RIGHT HERE: INTERIOR QUIETNESS.  
AMPLE ROOM. AVAILABLE RECONFIGURABLE CONSOLE.

## **RAM 1500 EXCEEDS STANDARDS.**

Interior quietness of only 67.1 dB. Premium materials throughout all trim levels. Available reconfigurable front center console. Rear flat load floor for increased leg room and abundant in-cabin cargo space. Best-in-class rear leg room of 45.1 in.<sup>1</sup> Passenger-friendly available fold-down rear center console. Available tablet holder for rear-seat passengers. Available 12-way power front seats, including 4-way lumbar adjust and three levels of adjustable heat/ventilation. Available reclining rear seat with eight-degree recline.<sup>2</sup>



# OUTSTANDING RIDE AND ROAD MANNERS

CLASS-EXCLUSIVE: THE MULTILINK COIL SPRING REAR SUSPENSION<sup>1</sup>  
AND AVAILABLE ACTIVE-LEVEL™ FOUR-CORNER AIR SUSPENSION SYSTEM.<sup>1</sup>

## A DIFFERENT WAY OF LOOKING AT SUSPENSIONS.

While many competitive trucks still use leaf-spring suspension technology, Ram 1500 stands alone in its class<sup>1</sup> with the comfort and durability of the multilink coil spring rear suspension system. For even more control, opt for the available Active-Level Four-Corner Air Suspension.





## TECHNOLOGY. IN EXTRA LARGE.

LARGEST AVAILABLE UCONNECT® TOUCHSCREEN IN ITS CLASS; SHOWN ABOVE WITH APPLE CARPLAY®<sup>3</sup> INTEGRATION FOR YOUR IPHONE®.



# SUPREMEY CAPABLE

THE CONFIDENCE OF 12,750-LB MAX TOWING.\*



**THE TRUE TEST OF TOUGH TOWING: DO IT BY THE TON.** Properly equip a Ram 1500, opt for the available 5.7L HEMI® V8 with eTorque, and you've got the perfect combination of capability, comfort and confidence.





RAM 1500 BEGINS WITH  
*A STRONG STRUCTURE*



LOOK INTO YOUR 2020 RAM 1500 AND YOU'RE LOOKING AT PURE CAPABILITY.

**CLASS IV TOWING HITCH**

Trailering is part of Ram DNA. The available Class IV trailer hitch makes it happen.

**HOW TO BOOST TOWING**

The available Max Tow Package—with its massive 10-inch rear axle—confidently ramps max towing up to 12,750 lb.<sup>4</sup>



**FOUR-CORNER AIR SUSPENSION<sup>1</sup>**

The available Active-Level™ Four-Corner Air Suspension is ideal for towing, maintaining an even and level profile when loaded.

**SMART FRONT AND REAR SUSPENSIONS**

What works: a heavy-duty front stabilizer bar and class-exclusive standard link coil rear suspension<sup>1</sup>



**PROGRESSIVE-RATE REAR SPRINGS**

They automatically adapt to payload while helping maintain a level profile and superb ride quality.

**REAR-AXLE THERMAL MANAGEMENT SYSTEM**

This available technology controls lubricant viscosity—a real contribution to the impressive efficiency.

**HIGH-STRENGTH STEEL**

The frame takes the concept of durability to extremes. 98 percent of the steel used in the frame is high-strength steel.

**SMART SHOCKS**

Frequency Response Damping (FRD) shock absorbers adapt to varying surfaces and driver demand.

**RIDE STRONG. WITH RAM 1500, IT'S ALWAYS ALL SYSTEMS GO.** From the foundation—a frame in which 98 percent of the steel is high-strength—to the available automatic or driver-operated Active-Level Four-Corner Air Suspension System, your Ram 1500 is a rolling example of how systems

work together to deliver exceptional performance. Whether it's the tow/haul engineering that enables you to tow big loads or the available rear-axle thermal management system that keeps things running smoothly, this is one pickup ready and Built to Serve.



**FROM TOUGH STEEL TO AIR BAGS<sup>5</sup>, SAFETY AND SECURITY ARE AN INTEGRAL PART OF EVERY RAM 1500.**



Crew Cab models with optional front crash prevention and specific headlights built after May 2019

**ELECTRONIC PARKING BRAKE**

Multifunctional, it features five operational modes, including Safe Mode and Drive-Away Release.

**MASSIVE BRAKES**

They rank as the largest-in-class<sup>1</sup>: front and back, these rotors are nearly 15 inches in diameter.

**AIR BAG<sup>5</sup> TECHNOLOGY**

It's formidable and includes advanced multistage front air bags<sup>5</sup>; supplemental front-seat side-mounted air bags<sup>5</sup> and side-curtain air bags<sup>5</sup>.

**SPLAYED FRAME RAILS**

These smartly engineered components direct energy away from the cabin and into the frame rails.



**AVAILABLE SENSORS, CAMERAS AND TECHNOLOGY**

There's still more to Ram 1500 that works to protect you. Details on additional systems are below.

**SIDE-IMPACT DOOR BEAMS**

Built into every Ram 1500, they reinforce protection against side impacts.

**TIRE BLOCKER**

Integrated into this frame are tire blockers—one per side—offering further protection in the event of a frontal crash.

**DYNAMIC FRONT CRUMPLE ZONES**

A real factor that contributes to safety, they absorb the energy from impact loads.

**OVER 100 AVAILABLE SAFETY AND SECURITY FEATURES.** If you're counting on ample safety and security, count on a 2020 Ram 1500. In addition to the physical strengths listed here are highly sophisticated examples of available software, sensors and camera technology. Available features include:

LaneSense® Lane Departure Warning Plus,<sup>6</sup> Adaptive Cruise Control with Stop & Go,<sup>7</sup> Forward Collision Warning with Active Braking,<sup>8</sup> Blind Spot Monitoring,<sup>9</sup> SmartBeam® Intelligent Headlamps, directional headlamps, the 360° Surround-View Camera System<sup>10</sup> ... and much more.



# DRIVE YOUR DREAMS. AVAILABLE MAX TOW PACKAGE

THE REALITY: UP TO 18,350-LB GCWR<sup>11</sup>



**RAM 1500 TURNS THE EXCEPTIONAL INTO THE EVERYDAY.**  
Boost your towing. The available Max Tow Package adds a 10-inch rear axle with a 3.92 axle ratio, a Trailer Brake Controller, a Class IV hitch receiver, the Trailer-Tow Group and robust 18 x 8-inch wheels.



AVAILABLE INNOVATIVE SUSPENSIONS AND MONITORING TECHNOLOGY.



WE'RE ALL ABOUT MAKING TOWING EASIER.

LED HEADLAMPS



360° SURROUND-VIEW CAMERA SYSTEM<sup>10</sup>



SELF-LEVELING AIR SUSPENSION

EASE OF HITTING WITH AIR SUSPENSION

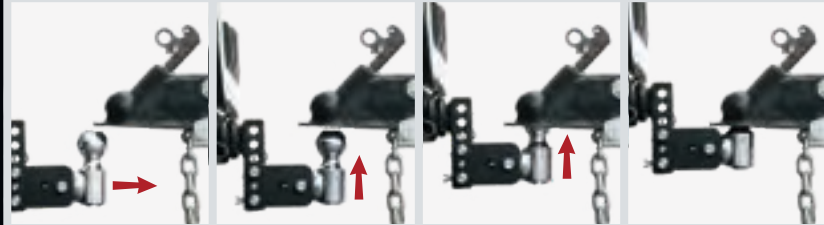



OVER 100 AVAILABLE SAFETY AND SECURITY FEATURES.

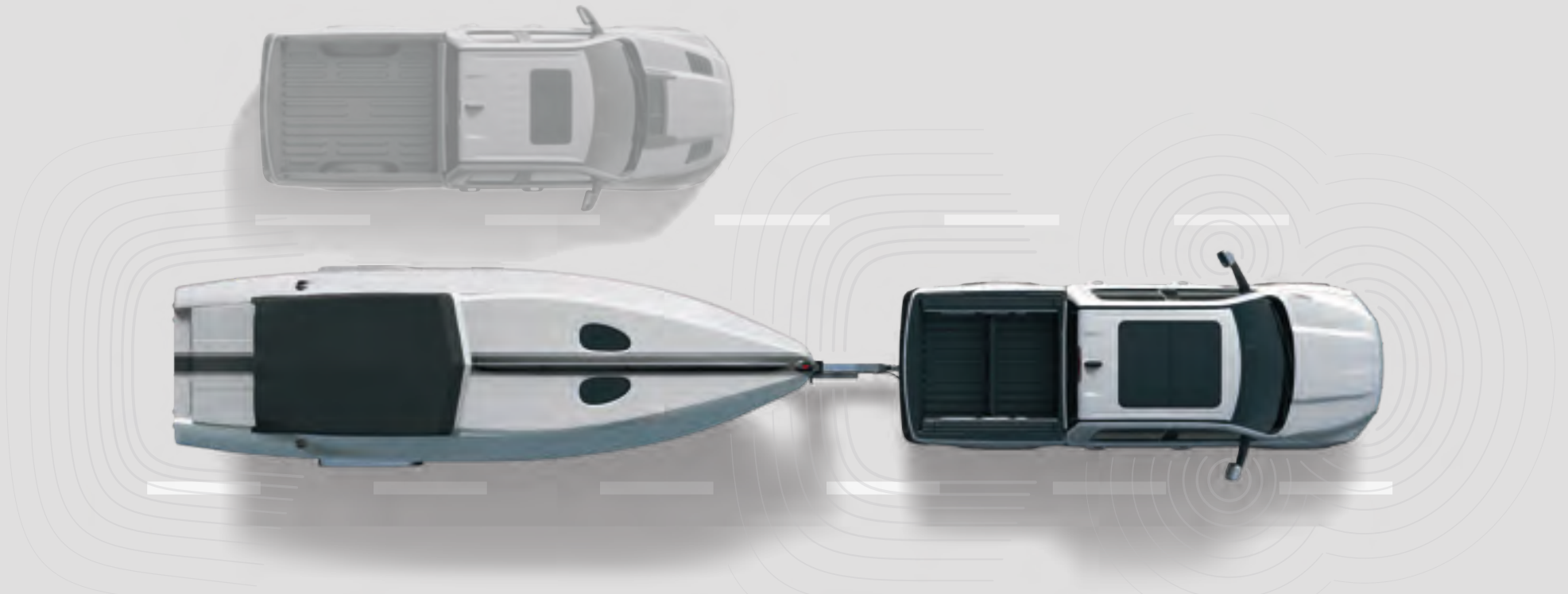

## SECURITY WHERE IT MATTERS MOST.

### **AVAILABLE LANESENSE® LANE DEPARTURE WARNING PLUS (LDW+)<sup>6</sup>**

Ram 1500 can read the road. Mounted on the external sideview mirrors, cameras can identify road lines, determine where the vehicle is and monitor motion. Should movement onto either line occur without use of the turn indicator, the system will warn the driver and apply torque to the steering wheel to correct the movement. If no action is taken to correct the drift, the system will automatically align the vehicle back into its correct lane position.

### **AVAILABLE ADAPTIVE CRUISE CONTROL WITH STOP AND GO (ACC+)<sup>7</sup>**

Think cruise control that's smarter than ever. When the lanes ahead are clear, this system maintains the set speed of travel. When traffic slows, it will automatically adjust to a safe distance selected by the driver. And, while most ACC+<sup>7</sup> systems operate only down to 20 mph, our system operates down to 0 mph, virtually stopping the vehicle—then reengaging back to safe-range speeds as traffic begins to move again. (Note that the system does not perform “panic stops” at speed.)

### **AVAILABLE FORWARD COLLISION WARNING WITH ACTIVE BRAKING (FCW+)<sup>8</sup>**

Incorporates grade braking to control the transmission and automatically downshifts to maintain selected speed and distance. The system operates independent of the ACC+<sup>7</sup> system, notifies the driver if too close to a preceding vehicle, uses audible/visual warnings and increases braking if the driver isn't responding, even braking the vehicle to 0 mph (if under 32 mph).

### **AVAILABLE REAR CROSS-PATH DETECTION<sup>10</sup>**

When in Reverse and vehicles and/or other objects are in perpendicular relationships to your Ram pickup, dual wide-band radar sensors let you know, using illuminated icons in the outside mirrors and driver-selected chimes.

### **AVAILABLE BLIND SPOT MONITORING (BSM)<sup>9</sup> WITH TRAILER DETECTION<sup>10</sup>**

This asset monitors the “blind spots” on each side of the vehicle, utilizing sensors in each of the side mirrors, providing audible chimes and/or visual icons to inform the driver when changing lanes, passing others or being passed. Trailer Detection<sup>10</sup> senses and accounts for the length of the trailer.

# THE AVAILABLE 3.0L ECODIESEL V6: 260 HP | 480 LB-FT



## WELCOME TO THE THIRD GENERATION: TURBOCHARGED AND STRONGER THAN EVER.

You asked for it—and we delivered. Compared to the previous version, the new, updated and revised 3.0L EcoDiesel V6 delivers 14 percent greater torque: it's now up to a best-in-class diesel torque of 480 lb-ft, easily handling big towing and hauling assignments. To that, add eight percent greater horsepower, along with new availability for every 2020 Ram 1500 model—including, for the first time, Ram Rebel.®



**5 YEAR / 100,000 MILE<sup>12</sup>**  
POWERTRAIN LIMITED WARRANTY



QUAD CAB® 6' 4" BOX  
12,560-LB MAX TOW CAPACITY<sup>4</sup>  
2,040-LB MAX PAYLOAD CAPACITY<sup>4</sup>



CREW CAB 5' 7" BOX  
9,910-LB MAX TOW CAPACITY<sup>4</sup>  
1,800-LB MAX PAYLOAD CAPACITY<sup>4</sup>



CREW CAB 6' 4" BOX  
9,950-LB MAX TOW CAPACITY<sup>4</sup>  
1,750-LB MAX PAYLOAD CAPACITY<sup>4</sup>





## THE AVAILABLE 5.7L HEMI® V8

**395 HORSEPOWER | 410 LB-FT OF TORQUE**



### AVAILABLE eTORQUE TECHNOLOGY WITH A SUPPLEMENTAL 130 LB-FT OF eTORQUE.

Providing more than just torque, available eTorque works with the standard Multi-Displacement System (MDS)/Fuel Saver Technology to deliver best-in-class available V8 4x4 fuel economy<sup>13</sup> and unsurpassed available V8 4x4 driving range—up to 572 miles.<sup>14</sup> The eTorque electric motor creates a mild-hybrid system to help refine Stop/Start capability; it also creates a generator for the regenerative braking, converting kinetic energy to recharge the battery system.



QUAD CAB® 6' 4" BOX

HEMI V8	11,620-LB MAX TOW CAPACITY <sup>4</sup> 1,910-LB MAX PAYLOAD CAPACITY <sup>4</sup>
HEMI V8 eTORQUE	12,750-LB MAX TOW CAPACITY <sup>4</sup> 1,820-LB MAX PAYLOAD CAPACITY <sup>4</sup>



CREW CAB 5' 7" BOX

HEMI V8	11,540-LB MAX TOW CAPACITY <sup>4</sup> 1,840-LB MAX PAYLOAD CAPACITY <sup>4</sup>
HEMI V8 eTORQUE	11,400-LB MAX TOW CAPACITY <sup>4</sup> 1,770-LB MAX PAYLOAD CAPACITY <sup>4</sup>



CREW CAB 6' 4" BOX

HEMI V8	11,490-LB MAX TOW CAPACITY <sup>4</sup> 1,790-LB MAX PAYLOAD CAPACITY <sup>4</sup>
HEMI V8 eTORQUE	11,400-LB MAX TOW CAPACITY <sup>4</sup> 1,690-LB MAX PAYLOAD CAPACITY <sup>4</sup>

**5 YEAR/60,000 MILE<sup>12</sup>**  
POWERTRAIN LIMITED WARRANTY



## THE 3.6L PENTASTAR® V6 WITH eTORQUE

**305 HORSEPOWER | 269 LB-FT OF TORQUE**



### THE STANDARD ENGINE FOR RAM 1500: SUPERB POWER, ALONG WITH BEST-IN-CLASS STANDARD V6 FUEL ECONOMY<sup>15</sup>—AND MORE.

The facts: a high 10.2:1 compression ratio. High torque—including a supplemental 90 lb-ft of eTorque—and over a broad rpm range: nearly 90 percent of peak torque is available from 1,800 to 6,400 rpm. eTorque utilizes a belt starter-generator system, a 48-volt lithium-ion battery, regenerative braking and electronic power boost. It all helps create a best-in-class standard V6 4x4 highway driving range—up to 624 miles.<sup>16</sup>



QUAD CAB 6' 4" BOX

7,710-LB MAX TOW CAPACITY<sup>4</sup>  
2,300-LB MAX PAYLOAD CAPACITY<sup>4</sup>



CREW CAB 5' 7" BOX

7,620-LB MAX TOW CAPACITY<sup>4</sup>  
2,000-LB MAX PAYLOAD CAPACITY<sup>4</sup>



CREW CAB 6' 4" BOX

7,580-LB MAX TOW CAPACITY<sup>4</sup>  
1,960-LB MAX PAYLOAD CAPACITY<sup>4</sup>

**5 YEAR/60,000 MILE<sup>12</sup>**  
POWERTRAIN LIMITED WARRANTY

**THE MUSCLE AND MECHANICS OF PURE CAPABILITY.**

Think robust and resilient frame with plenty of advanced high-strength steel. Formidable suspension technology. Steel cargo bed. Yeah, load it up. Ram 1500 is built to take it.

BORN TO HAUL. **2,300-LB MAX PAYLOAD<sup>4</sup>**  
ON 3.6L V6 QUAD CAB<sup>®</sup> 4x2





# MULTIFUNCTION TAILGATE

## SMART. SIMPLE. STRONG.

We specialize in innovative cargo management—leading the way with the available class-exclusive RamBox® Cargo Management System<sup>1</sup>—so it's no surprise to find an available multifunction tailgate to make life easier. With a 60/40-split design (larger door on the left), it opens side-to-side or vertically in typical tailgate fashion, and with the damped ease of operation when opening. Requires spray-in bedliner at additional cost.

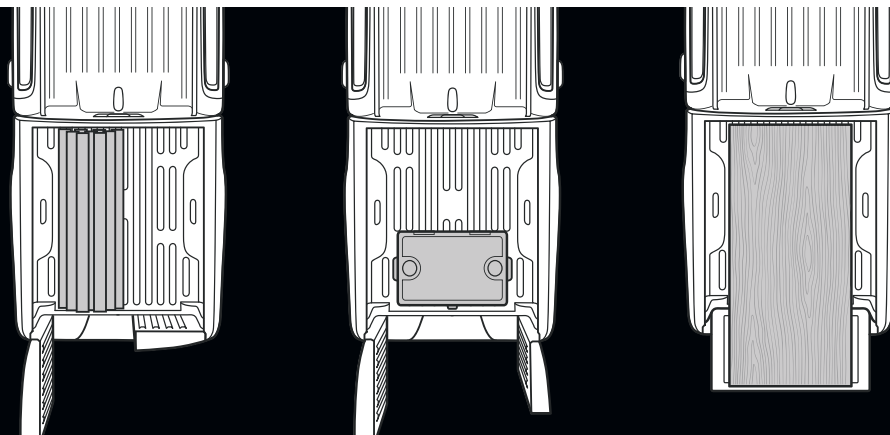

# RAM 1500: INSPIRED STORAGE SOLUTIONS.



## AVAILABLE RAMBOX® CARGO MANAGEMENT SYSTEM:<sup>1</sup>

This truck is all about discovering smarter, more efficient ways to handle cargo. Start with a conventional cargo bed and a maximum volume of 61.5 cu ft. Now proceed to the available RamBox System with those versatile, illuminated, weatherproof, lockable and drainable storage bins—and a 115-volt power outlet. Where it all ends is where life is good: total convenience, total capability.

## ALL-POWERFUL KEY FOB

Available features: remote operation of doors and RamBox System locks, a tailgate release, lowering the Air Suspension mode and the Remote Start System.<sup>17</sup>

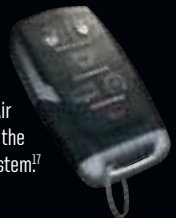





**TAKE IT ALL WITH YOU** The available class-exclusive RamBox® Cargo Management System<sup>1</sup> gives you covered and secure storage while still allowing traditional bed space for the essentials.

**STANDARD SHEETS FIT** The available RamBox System enlarges storage, while the bed still accommodates standard 4x8-foot sheets of building materials.

**MANAGE YOUR CARGO** Want to keep certain items of cargo separate? The available Bed Utility Group offers a bed divider and a cargo rail system with four adjustable tie-down loops.

**IN-BED LED LIGHTING** Controlled by a switch or a key fob button, these available side cargo-bed lights let you load anytime and with no adjustment to a tonneau cover (if so equipped).

**115-VOLT POWER OUTLET** It's handily located in the driver's-side bin of the available RamBox Cargo Management System.

**DAMPED TAILGATE** Opens more slowly and closes more easily. Available power-release lets you open it with the key fob button or via the overhead console.

**STEEL DEPLOYABLE BED STEP** Eases cargo access. Foot-controlled for use or to tuck it back under the bed. Easily installed, with a slip-resistant rubber coating. Included in the available Bed Utility Group or available as a stand-alone Mopar® option.

# THINK OF IT AS AIR POWER.



## YOUR RAM 1500, AND SPACE-AGE WIND MANAGEMENT.

The better the aerodynamics, the more efficient the pickup. Factors that contribute to the aerodynamic efficiency and minimal drag of Ram 1500 include the Active Front Air Dam, a roofline that better directs airflow and an aluminum tailgate with spoiler.



**ACTIVE GRILLE SHUTTERS** Standard on all models, Active Grille Shutters instantly adapt to speed, load and engine needs to provide ideal engine cooling—while simultaneously reducing aerodynamic drag.

**AERO ROOF SHAPE** The Ram 1500 exterior design translates into a long wheelbase for Crew Cab models, muscular fenders and a sleek roofline that better directs airflow back to the rear spoiler. The aero roof also allowed the design of the available dual-pane sunroof.

**SMART TAILGATE DESIGN** An aluminum tailgate with integrated spoiler not only contributes to the aerodynamic quality, it also gives the pickup a seamless, unbreakable appearance. Additional tailgate advantages: the available “Tailgate-ajar” notification system alerts you if the tailgate isn’t completely closed, while available damping and key fob control make opening the tailgate a breeze.

**ACTIVE AIR DAM** This engineering automatically deploys at 30 mph to help lessen aerodynamic drag. Mitigating drag helps improve handling and even helps contribute to reduced fuel consumption.



# TECHNOLOGY THAT'S SMART, FAST AND ADVANCED: HOW RAM 1500 KEEPS YOU CONNECTED WITH THE GOOD STUFF IN LIFE.

## IT'S BEST, AND BEST OF ALL, IT'S CUSTOMIZED BY YOU.

This is powerful, user-friendly technology that delivers premium levels of entertainment, communications, comfort and convenience—and which brings together a wealth of technologies. The latest-generation Uconnect® system encompasses everything from built-in available cellular connectivity to personalized settings for available features like Keyless Enter 'n Go™, heated/ventilated seats and more.

**Uconnect®**

Largest-in-class available 12-inch reconfigurable touchscreen,<sup>1</sup> with one-touch, customizable "Home Screen." Available on select trim levels.

• Available SiriusXM® Radio with 360L<sup>18</sup> (includes 1-year trial)

**SiriusXM**

• Apple CarPlay<sup>®3</sup> support



• Android Auto<sup>™19</sup> integration

**android**  
auto

• Available SiriusXM Guardian<sup>™20</sup> Connected Services (includes 1-year trial)

**SiriusXM**  
**GUARDIAN**

• Available SiriusXM Traffic Plus<sup>18</sup> and SiriusXM Travel Link<sup>18,21</sup> (includes 5-year trial)

**SiriusXM**      **SiriusXM**  
**TRAFFIC PLUS**    **TRAVEL LINK**

• Uconnect Smartphone App

• Multi-touch gesturing (e.g., pinch-to-zoom, touch/drag, etc.)

• Available 4G LTE WiFi Hotspot<sup>22</sup> (1-gigabyte/3-month trial)

• Available full-screen Uconnect Navigation with pinch-to-zoom

• Bluetooth<sup>®</sup> hands-free phone capability<sup>23</sup> and Voice Text Reply<sup>24</sup>

• Uconnect Integrated Voice Command

• Siri<sup>®</sup> Eyes Free<sup>25</sup>

**PERSONALIZED STATIONS POWERED BY PANDORA<sup>®</sup>**

Available on Ram trucks with SiriusXM 360L<sup>18</sup>; with the available Uconnect 12-inch touchscreen, you can create your own artist-based, ad-free music station. Curate your playlists, skip songs and give a thumbs-up.





# IT'S JUST PLAIN SMART. THE AVAILABLE LARGEST-IN-CLASS TOUCHSCREEN<sup>1</sup> GIVES YOU TOTAL VERSATILITY.

**CUSTOMIZE THE DISPLAY TO BEST SERVE YOUR NEEDS. INTUITIVE UCONNECT<sup>®</sup> TOUCHSCREEN LETS YOU COMMUNICATE, NAVIGATE AND STAY ENTERTAINED.**

## **AVAILABLE FEATURES INCLUDE:**

**LISTEN** to music, talk shows and sports. Access all genres, favorite artists, winning teams—all the time—with SiriusXM<sup>®</sup> Radio featuring the comprehensive 360L<sup>18</sup> experience, including a one-year trial subscription.

**DISCOVER** new places and the best shopping, entertainment and restaurants from the Uconnect App; easily send the address to your vehicle.

**SPEAK UP** and be heard; send and receive calls and texts<sup>24</sup> while driving safely with hands-free phone capability<sup>23</sup>

**NAVIGATE** to every adventure; get turn-by-turn directions so you don't get lost on the way (unless, of course, you want to).

**START** your car from afar, get your engine running, unlock your door or flash your headlamps from almost anywhere using your smartphone with SiriusXM Guardian<sup>TM20</sup> Remote Services<sup>26</sup> and the Uconnect App.

**KEEP** informed; receive weather and traffic reports with a five-year trial subscription to SiriusXM Travel Link<sup>18,21</sup> and SiriusXM Traffic Plus.<sup>19</sup>

**THE SIRIUSXM WITH 360L<sup>18</sup> EXPERIENCE** is a groundbreaking next-generation platform, delivering more SiriusXM channels and variety to the vehicle by delivering content via both satellite and streaming. It gives the user more choices at their fingertips and allows for a more personalized "lean back" experience as SiriusXM serves content recommendations based on your listening preferences. Drivers and their passengers will find it easier to discover more of what SiriusXM offers, including exclusive SiriusXM On Demand programming. And now you can create your own ad-free music stations based on the artists you're listening to. On the available 12-inch Uconnect touchscreen, subscribers can then give songs a thumbs-up or thumbs-down within the SiriusXM service, or even skip songs, to create their own personal channel that plays more of what they want. We put the most amazing content in front of you, and you're in the driver's seat.

## **APPLE CARPLAY<sup>®3</sup> SUPPORT.**

This is smart iPhone<sup>®</sup> integration so you'll experience some of your favorite features through your dashboard. With Siri<sup>®25</sup> all you have to do is ask—catch up on calls and messages, get directions from Apple Maps or request a song through Apple Music.<sup>®</sup> The system lets you browse music or discover nearby gas stations, parking, restaurants and more. Plus, Maps helps predict where you're headed.

## **ANDROID AUTO<sup>TM19</sup> INTEGRATION.**

For those who know and love Android,<sup>™</sup> Android Auto brings some of your favorite smartphone apps into one place, making it easy for drivers to access their favorite navigation, media, and communication apps on the road while minimizing the distractions. Stay focused on the road while you plan your day with Google Assistant, get voice-guided navigation with Google Maps, and listen to your favorite songs on Google Play Music.

Uconnect<sup>®</sup>

TECHNOLOGY  
FOR THE REAL WORLD





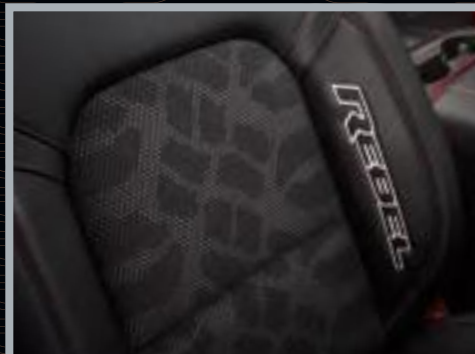

## BRILLIANT DETAILS

### THE FINE ART OF DESIGN: TEXTURES, MATERIALS AND PATTERNS.

For sure, there's beauty in hauling a ton, or towing huge boats and trailers. But we think there's also beauty in the details. You'll find them everywhere in a 2020 Ram 1500. Brilliant design touches span the gamut: the real wood and leather trim of Laramie Longhorn® and Limited, the Tire-Tread seat pattern of Rebel®, the intuitive and ergonomic controls, the eye-friendly instrumentation. Attention to detail is one of the greatest strengths of Ram 1500—the most luxurious truck in its class.<sup>27</sup>



The image shows the interior of a car, viewed from the passenger side looking towards the driver's seat. The sunroof is open, revealing a dark blue night sky filled with stars. The car's interior is dark, with black leather seats and a dashboard. A control panel with a red emergency button is visible on the right side of the dashboard. The text "OUT THERE IS RIGHT HERE." is centered in the upper half of the image.

OUT THERE IS RIGHT HERE.

# RAM LIMITED

**UNLIMITED SOPHISTICATION. BENCHMARK LUXURY.**

It's the Ram 1500 flagship for opulence—and it gives you just about every element of craftsmanship imaginable. Ram Limited: where there are no limits to refinement.

## TOTAL COMFORT. ZERO COMPROMISE.





# RAM LIMITED



- ▶ Largest-in-class Uconnect® 12-inch touchscreen<sup>1</sup> with Navigation and SiriusXM Guardian™<sup>20</sup>
- ▶ Alpine® 10-speaker sound system standard; Harman Kardon® 19-speaker sound system with the highest number of speakers in its class<sup>1</sup> available
- ▶ 7-inch programmable in-dash cluster
- ▶ Active-Level™ Four-Corner Air Suspension System
- ▶ Blind Spot Monitoring<sup>9</sup> with Rear Cross-Path and Trailer Detection<sup>10</sup>

See more at [RAMTRUCKS.COM](https://RAMTRUCKS.COM)





# RAM LARAMIE LONGHORN®

**REFINED CAPABILITY. SOME SAY, BEST IN THE FIELD.**

We're inclined to agree. With its distinctive Southwestern theme, Laramie Longhorn offers fine styling choices that include monotone or two-tone exterior treatments. It's echoed inside with leather trim—with or without etching.







**ONE EXCEPTIONAL TRUCK. ONE EXCEPTIONAL WHEEL.**

For Ram 1500 Laramie Longhorn® drivers who choose the two-tone exterior: a new, available 22-inch two-tone wheel with Walnut touches gives you a new sense of authority and powerfully communicates what counts: personal style.

# RAM LARAMIE LONGHORN®



- ▶ Uconnect® 4C NAV with 8.4-inch display
- ▶ Premium Natura-Plus leather bucket seats and leather rear seats
- ▶ 60/40 rear split-reclining bench seat with fold-down console
- ▶ Full LED bi-projector headlamps with adaptive front lighting
- ▶ Chrome side steps, chrome tow hooks and 20-inch aluminum wheels

See more at [RAMTRUCKS.COM](https://RAMTRUCKS.COM)





# RAM LARAMIE®

## GO WHERE LIFE TAKES YOU—IN COMPLETE LUXURY.

You know it the minute you see it: Laramie is refinement that rules. Count on a sleek exterior riding on 18-inch cast aluminum wheels and an interior so focused on comfort, there's even an available reclining rear seat.<sup>2</sup>



# RAM LARAMIE®



- ▶ 7-inch premium color cluster and 10-speaker premium audio system with subwoofer
- ▶ Front heated and ventilated leather-trimmed seats with 12-way power for driver and front passenger
- ▶ Power-sliding rear window, Remote Start System<sup>17</sup> and auto-dimming power-folding exterior mirrors
- ▶ LED fog lamps, taillamps and headlamps with dual signatures
- ▶ 18-inch aluminum wheels and Class IV trailer hitch

See more at [RAMTRUCKS.COM](https://RAMTRUCKS.COM)





# REBEL



WE CHAMPION THE REBEL WITHIN.  
IT'S WHY WE CREATED THIS TRUCK.

**LET'S BE GRAPHICALLY CLEAR ABOUT GOOD LOOKS.**

It totally commands attention, but your Ram Rebel® can further stand out with some very attractive optional eye candy—like this decal package for the side and hood, and the new Black Appearance Package with a new 18-inch Black wheel.



# RAM REBEL<sup>®</sup>



## HONOR THE OFF-ROAD.

- ▶ Black powder-coated steel bumpers, aggressive approach angles and tow hooks
- ▶ Electronic locking rear axle (eLocker) with factory lift for one-inch increase in ride height
- ▶ Bilstein<sup>®</sup> off-road shocks, Hill Descent Control, and Class IV hitch receiver
- ▶ Unique Black wheel flares and unique Ram scripted aluminum tailgate with damped opening assist
- ▶ 18-inch aluminum wheels and On-/Off-Road 33-inch tires with Outlined White Lettering (OWL)

See more at [RAMTRUCKS.COM](https://RAMTRUCKS.COM)



Ram Rebel with optional multifunction tailgate



# RAM REBEL®

ORDINARY? TRY EXTRAORDINARY.

- ▶ Uconnect® radio with 5-inch display standard; 8.4-inch and 12-inch displays available
- ▶ Rebel themed interior with 7-inch, full-color, reconfigurable 6-gauge cluster
- ▶ 12-way power driver's seat with 4-way headrest
- ▶ Unique laser-ingrained Dark Ruby Red accents, Black/Dark Ruby Red premium seats
- ▶ Rebel themed floor mats and leather-wrapped steering wheel

See more at [RAMTRUCKS.COM](https://RAMTRUCKS.COM)







**ANY WAY YOU LOOK AT IT, RAM REBEL® STANDS APART.**

The name telegraphs unconventional attitude, and the fine points emphasize uncompromising capability. Like that Sport Performance Hood, a one-inch increase in ride height, monster 33-inch tires and a Class IV hitch receiver ready to tow.



# RAM BIG HORN® / LONE STAR<sup>28</sup>

## CONFIDENCE MEETS COMFORT.

Choose your power: the 3.6L Pentastar® V6 with eTorque is standard. Available: the 5.7L HEMI® V8, the 5.7L HEMI V8 with eTorque and the 3.0L EcoDiesel V6. The capability is stunning—as are the technology and interior comfort.



# RAM BIG HORN® / LONE STAR<sup>28</sup>



- ▶ Uconnect® 3 with 5-inch display with Integrated Voice Command and Bluetooth®
- ▶ Leather-wrapped steering wheel, three USB ports and 3.5-inch cluster
- ▶ Cloth front bench seat, carpeted floor and 60/40-split rear bench seat
- ▶ Quad-halogen headlamps, fog lamps and incandescent taillamps
- ▶ 18-inch aluminum wheels, chrome grille and chrome bumpers

See more at [RAMTRUCKS.COM](http://RAMTRUCKS.COM)





# RAM TRADESMAN<sup>®</sup>

## AN IDEAL COMBINATION OF CAPABILITY AND CHARACTER.

You put in full-time effort, and this full-size pickup is ready for it, coming to work with a standard 3.6L Pentastar<sup>®</sup> V6 with eTorque and big 18-inch wheels. For a custom look that's totally you, equip your Tradesman with the available Chrome Appearance Group.



# RAM TRADESMAN<sup>®</sup>



- ▶ Vinyl 40/20/40-split front bench seat, full-folding rear bench seat and vinyl floor covering
- ▶ 20-percent fold-down center bench seat with integrated armrest
- ▶ Electronic shift-on-the-fly part-time transfer case (on 4x4 models only)
- ▶ Rear aluminum twin-tube heavy-duty shock absorbers with front and rear stabilizer bars
- ▶ 18-inch steel wheels and Class III trailer hitch

See more at [RAMTRUCKS.COM](https://RAMTRUCKS.COM)







## AUTHENTIC ACCESSORIES BY MOPAR<sup>®</sup>

When it comes to your 2020 Ram 1500, not all parts and accessories are created equal. As the official service, parts and customer care provider for the Ram Brand, only Mopar Parts and Accessories can ensure the proper fit, finish and functionality. That's because they're original equipment, engineered by the same people who designed your vehicle, which means you can customize your truck with complete confidence.

Mopar is also more than parts and accessories. We're here to help you properly maintain and care for your vehicle. Our certified technicians are trained to know your vehicle best, and our Mopar Express Lane service departments are set up to get you in and out quickly. From parts and accessories to expert service and more, always be sure to choose Mopar. Learn more at [mopar.com](https://www.mopar.com)

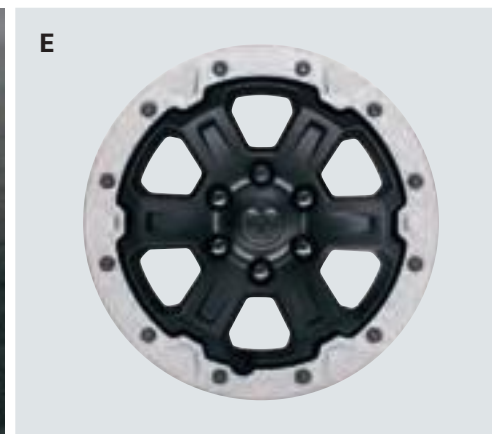
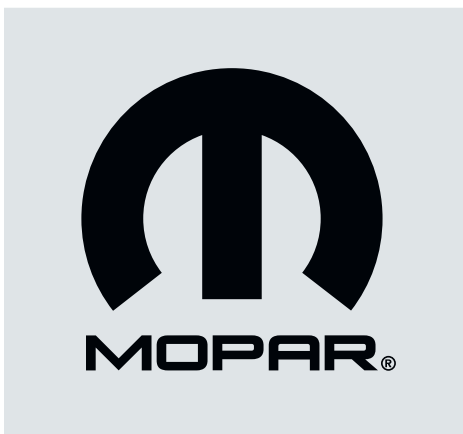

- A.** Off-Road-Style Running Boards
- B.** Drop-In Bedliner
- C.** Soft Roll-Up Tonneau Cover
- D.** 2-inch Lift Kit<sup>29</sup>
- E.** Beadlock-Capable Wheel
- F.** Bed Extender

## RAM 1500 TRIM LEVELS

### TRADESMAN®



#### POWERTRAIN

3.6L Pentastar® V6 Variable Valve Timing (VVT) with eTorque/8-speed automatic  
 5.7L HEMI® V8 Multi-Displacement System (MDS) VVT/8-speed automatic  
 5.7L HEMI V8 MDS VVT with eTorque/8-speed automatic  
 3.0L EcoDiesel V6/8-speed automatic

#### STANDARD FEATURES

#### INTERIOR AMENITIES

Vinyl 40/20/40-split front bench seat with manual adjust  
 20-percent fold-down center bench seat with integrated armrest  
 Full stadium-folding rear bench seat  
 Base door trim panel  
 Black instrument panel

Uconnect® 3 with 5-inch display  
 Urethane steering wheel  
 Manual tilt/telescoping steering column  
 Manual Temperature Control  
 USB port  
 Vinyl floor covering

#### EXTERIOR FEATURES

Black grille  
 Black front bumper  
 Quad-halogen headlamps  
 18-inch steel wheels  
 Black door handles

Black rear bumper  
 Incandescent taillamps  
 P18-inch BSW All-Season tires  
 Manual-folding mirrors

#### CAPABILITY & FUNCTIONALITY

Electronic shift-on-the-fly part-time transfer case (4x4 only)  
 Keyless push-button start  
 Trailer-tow wiring with 4- and 7-pin connector  
 Speed control  
 Electronic power rack and pinion steering  
 Front twin-tube heavy-duty shocks with Frequency Response Damping (FRD)

Rear aluminum twin-tube heavy-duty shocks with FRD  
 14.9-inch/14.8-inch front/rear brake rotors  
 Front and rear stabilizer bars  
 Rear fixed window  
 Active Grille Shutters  
 Active Front Air Dam  
 Class III hitch receiver

#### SAFETY & SECURITY

Six air bags<sup>5</sup> including driver and front-passenger, side-curtain and front-seat side-mounted  
 Electronic Stability Control (ESC)<sup>30</sup>  
 Antilock 4-wheel disc brakes  
 Sentry Key® Theft Deterrent System

Remote Keyless Entry  
 Tire Pressure Monitoring System with display  
 Tire-Fill Alert System  
 ParkView® Rear Back-Up Camera<sup>10</sup>  
 Electronic Parking Brake

#### APPEARANCE PACKAGES



#### Chrome Appearance Group

Includes chrome grille surround and front brow bezel, chrome bumpers, chrome Ram grille badge, 18-inch cast aluminum wheels with premium paint finish and cloth 40/20/40-split front bench seat

### BIG HORN® / LONE STAR<sup>28</sup>



#### POWERTRAIN

3.6L Pentastar V6 VVT with eTorque/8-speed automatic  
 5.7L HEMI V8 MDS VVT/8-speed automatic  
 5.7L HEMI V8 MDS VVT with eTorque/8-speed automatic  
 3.0L EcoDiesel V6/8-speed automatic

#### STANDARD FEATURES INCLUDE SELECT TRADESMAN FEATURES PLUS:

#### INTERIOR AMENITIES

Cloth 40/20/40 front bench seat  
 Cloth 60/40 rear split-bench seat  
 Carpet floor covering  
 Manual 4-way driver's and passenger seats  
 Premium vinyl door trim panel  
 3.5-inch monochrome cluster

Leather-wrapped steering wheel  
 Hydrographic "metal patina" finish on center stack/console and doors  
 Three USB ports – Two located on lower left and one in upper lid of bench seat

#### EXTERIOR FEATURES

Chrome-surround/Black billet grille  
 Chrome front brow bezel  
 Chrome bumpers  
 Fog lamps

18-inch aluminum wheels  
 Chrome-insert door handles  
 Big Horn / Lone Star<sup>28</sup> badge  
 Manual-folding/power mirrors

#### CAPABILITY & FUNCTIONALITY

Electronic shift-on-demand transfer case (4x4 only)

Rear manual-sliding window  
 "Tailgate-ajar" warning lamp

#### APPEARANCE PACKAGES



#### Sport Appearance Package

Includes body-color grille surround, body-color bumpers, monotone paint, body-color mirrors, body-color door handles, monotone Black interior trim and cloth bucket seats

#### Night Edition

Includes Black grille, body-color bumpers, 20-inch cast aluminum Black-painted wheels, monotone paint, Black badges, Black headlamp bezels, Black taillamp bezels, Black exhaust tips (with HEMI V8), monotone Black interior trim and cloth bucket seats





## RAM 1500 TRIM LEVELS

### REBEL®



#### POWERTRAIN

3.6L Pentastar® V6 Variable Valve Timing (VVT) with eTorque/8-speed automatic  
 5.7L HEMI® V8 Multi-Displacement System (MDS) VVT/8-speed automatic  
 5.7L HEMI V8 MDS VVT with eTorque/8-speed automatic  
 3.0L EcoDiesel V6/8-speed automatic

STANDARD FEATURES  
 INCLUDE SELECT BIG HORN® / LONE STAR<sup>2B</sup> FEATURES PLUS:

#### INTERIOR AMENITIES

Unique Black interior trim with Red accents  
 Vinyl/cloth bucket seats with tire-tread pattern  
 Full-length reconfigurable center console  
 60/40 rear split-bench seat  
 Rebel rubber floor mats

12-way power driver's seat (with 4-way power lumbar)  
 7-inch Rebel color reconfigurable cluster  
 115-volt outlet  
 Three USB ports  
 SiriusXM® Radio<sup>1B</sup> with 1-year trial

#### EXTERIOR FEATURES

Black-surround unique grille  
 Sport Performance Hood  
 Powder-coated bumpers  
 LED headlamps and taillamps with Black bezels  
 LED fog lamps  
 Body-color door handles

Unique Black wheel flares  
 18-inch unique aluminum wheels  
 LT18-inch OWL On-/Off-Road tires  
 Unique Ram scripted aluminum tailgate with damped opening assist  
 Black dual exhaust included with HEMI V8 engines

#### CAPABILITY & FUNCTIONALITY

Electronic shift-on-the-fly part-time transfer case (4x4 only)  
 Class IV hitch receiver  
 Bilstein® off-road shocks  
 Tow hooks  
 Fuel tank skid plate

Electronic power steering skid plate  
 Transfer case skid plate  
 Front suspension skid plate  
 New electronic locking rear axle (eLocker)  
 1-inch raised ride height  
 Rear power-sliding window

#### SAFETY & SECURITY

Hill Descent Control

### LARAMIE®



#### POWERTRAIN

3.6L Pentastar V6 VVT with eTorque/8-speed automatic  
 5.7L HEMI V8 MDS VVT/8-speed automatic  
 5.7L HEMI V8 MDS VVT with eTorque/8-speed automatic  
 3.0L EcoDiesel V6/8-speed automatic

STANDARD FEATURES  
 INCLUDE SELECT BIG HORN / LONE STAR<sup>2B</sup> FEATURES PLUS:

#### INTERIOR AMENITIES

Leather-trimmed 40/20/40-split front bench seat  
 12-way power driver and front-passenger seats (with 4-way power lumbar)  
 Heated and ventilated front seats with memory  
 60/40 rear split-bench seat  
 7-inch premium color cluster  
 10-speaker premium audio system with subwoofer

SiriusXM Radio<sup>1B</sup> with 1-year trial  
 Uconnect® 4 with 8.4-inch display  
 Five USB ports, two power outlets  
 Universal Garage Door Opener  
 Dual-Zone Automatic Temperature Control  
 LED ambient interior lighting  
 Rear power-sliding window

#### EXTERIOR FEATURES

Chrome-surround/chrome billet grille  
 Chrome front and rear bumpers  
 Body-color wheel flares  
 LED headlamps and taillamps with chrome bezels  
 LED fog lamps

18-inch cast aluminum wheels  
 P18-inch BSW All-Season tires  
 Chrome-insert door handles  
 Laramie badge  
 Power-folding mirrors with chrome mirror caps

#### CAPABILITY & FUNCTIONALITY

Remote proximity keyless push-button start  
 Class IV hitch receiver

Remote Start System<sup>17</sup>

## APPEARANCE PACKAGES

#### Chrome Appearance Group

Includes monotone paint, chrome window-surround moldings, chrome tow hooks and chrome wheel-to-wheel side steps



#### Night Edition

Includes monotone paint, Sport Performance Hood, body-color bumpers, door handles/mirror caps, Black grille, badges, headlamp/taillamp bezels and (with the HEMI V8) exhaust tips, bucket seats, Black leather-trimmed interior and Black-painted aluminum wheels

#### Sport Appearance Package

Includes monotone paint, Sport Performance Hood, body-color grille surround, body-color bumpers, body-color door handles/mirror caps, Black leather-trimmed interior, front bucket seats with center console and 20-inch aluminum wheels with premium painted and polished inserts



## APPEARANCE PACKAGES



#### Black Appearance Package

Includes monotone Black paint color, Blackout treatment on grille, front skid plate and 18-inch Black-painted aluminum wheels

## RAM 1500 TRIM LEVELS

### LARAMIE LONGHORN®



#### POWERTRAIN

3.6L Pentastar® V6 Variable Valve Timing (VVT) with eTorque/8-speed automatic  
 5.7L HEMI® V8 Multi-Displacement System (MDS) VVT/8-speed automatic  
 5.7L HEMI V8 MDS VVT with eTorque/8-speed automatic  
 3.0L EcoDiesel V6/8-speed automatic

STANDARD FEATURES  
 INCLUDE SELECT LARAMIE® FEATURES PLUS:

#### INTERIOR AMENITIES

Laramie Longhorn specific premium leather trim and wood interior treatment  
 Premium leather front bucket seats with full-length center console  
 60/40 rear split-reclining bench seat with fold-down console  
 SiriusXM® Radio<sup>18</sup> with 1-year trial  
 Heated front and rear seats

Ventilated front seats  
 Leather-wrapped/real-wood steering wheel  
 7-inch Laramie Longhorn color cluster Uconnect® 4C NAV with 8.4-inch display  
 Premium rubber slush mats with removable carpet inserts  
 LED interior lighting

#### EXTERIOR FEATURES

Laramie Longhorn badge  
 Unique bright-surround/billet grille  
 Premium LED headlamps  
 LED taillamps  
 LED fog lamps

Chrome side steps  
 Chrome window surrounds  
 Chrome tow hooks  
 P20-inch BSW All-Season tires  
 20-inch aluminum wheels

#### CAPABILITY & FUNCTIONALITY

Power-release tailgate

Spray-in bedliner

#### SAFETY & SECURITY

ParkSense® Front and Rear Park Assist with Rear ParkSense Stop<sup>31</sup>

#### APPEARANCE PACKAGES



#### Body-Color Bumper Group

Includes front and rear body-color bumpers

#### Two-Tone Paint

Includes RV Match Walnut Brown paint for the lower body, front and rear bumpers, wheel flares, running boards and wheel inserts



### LIMITED



#### POWERTRAIN

3.6L Pentastar V6 VVT with eTorque/8-speed automatic  
 5.7L HEMI V8 MDS VVT/8-speed automatic  
 5.7L HEMI V8 MDS VVT with eTorque/8-speed automatic  
 3.0L EcoDiesel V6/8-speed automatic

STANDARD FEATURES  
 INCLUDE SELECT LARAMIE LONGHORN FEATURES PLUS:

#### INTERIOR AMENITIES

Limited-specific premium leather trim and wood interior treatment  
 Premium leather front bucket seats with full-length center console  
 60/40 rear split-reclining bench seat with fold-down console  
 SiriusXM Radio<sup>18</sup> with 1-year trial  
 Heated front and rear seats

7-inch Limited color cluster  
 Leather-wrapped/real-wood steering wheel  
 Uconnect 4C NAV with 12-inch display  
 Premium rubber slush mats with removable carpet inserts  
 LED interior lighting  
 Wireless charging pad

#### EXTERIOR FEATURES

Chrome-surround Limited-specific grille  
 20-inch cast aluminum wheels with premium painted inserts

Power running boards  
 Limited badge  
 Chrome bodyside molding

#### SAFETY & SECURITY

Blind Spot Monitoring<sup>9</sup> with Rear Cross-Path and Trailer Detection<sup>10</sup>

#### APPEARANCE PACKAGES



#### Body-Color Bumper Group

Includes front and rear body-color bumpers

#### Black Appearance Package

Includes Black exterior paint, Black grille, Black door handles and mirror caps, Black front and rear bumpers, Sport Performance Hood, tri-folding tonneau cover, Black tow hooks, 22-inch Black-painted aluminum wheels, dual Black exhaust tips (packaged with HEMI V8 or EcoDiesel V6), Black badges, Black window moldings, headlamps and taillamps with dark internal bezels, 19-speaker premium audio system and Black interior





## RAM 1500 WHEELS



18-inch Steel Painted  
Standard on Tradesman® (WBF)



18-inch Aluminum Painted  
Standard on Big Horn® / Lone Star<sup>28</sup>;  
Included with Max Tow Package on  
Tradesman and Laramie®; Included with  
Chrome Appearance Group or Sport  
Appearance Package on Tradesman (WBB)



18-inch Cast Aluminum Painted  
Black / Polished Finish  
Standard on Rebel® (WBT)



18-inch Gloss Black-Painted Aluminum  
Included with Black Appearance  
Package on Rebel (WBS)



18-inch Cast Aluminum  
Standard on Laramie (WBC)



20-inch Polished / Painted Aluminum  
Optional with Sport Appearance  
Package or Night Edition  
on Tradesman (WRF)



20-inch Cast Aluminum Chrome-Clad  
Optional on Big Horn / Lone Star<sup>28</sup> (WRK)



20-inch Aluminum Painted Black  
Included with Night Edition on Tradesman;  
Included with Black Appearance Package or  
Night Edition if equipped with Off-Road  
Group on Laramie and Limited (WRW)



20-inch Aluminum Premium Chrome-Clad  
Standard on HFE;  
Optional on Big Horn / Lone Star<sup>28</sup> (WRD)



20-inch Black-Painted Aluminum  
Included with Night Edition  
on Big Horn / Lone Star<sup>28</sup> (WRP)



20-inch Aluminum Premium  
Painted / Polished  
Optional on Laramie (WRB)



20-inch Aluminum Premium  
Painted / Polished / Insert  
Included with Sport Appearance  
Package on Laramie (WRJ)



20-inch Aluminum Premium  
Gray Paint / Polished  
Standard on Laramie Longhorn® (WRU)



20-inch Aluminum Premium  
Brown Paint / Polished  
Included with two-tone paint  
on Laramie Longhorn (WRC)



20-inch Polished Aluminum with Inserts  
Standard on Limited (WRR)



22-inch Aluminum Polished / Premium Paint  
Optional on Laramie with  
Sport Appearance Package (WPM)



22-inch Black-Painted Aluminum  
Included with Night Edition  
on Laramie (WPH)



22-inch Aluminum Premium Paint  
Optional on monotone  
Laramie Longhorn or Limited (WPZ)



22-inch Polished Aluminum with  
Brown-Painted Accents  
Optional on Laramie Longhorn  
with two-tone paint (WPF)



22-inch Black-Painted Aluminum  
Included with Black Appearance  
Package on Limited (WP9)

## CONFIGURATIONS

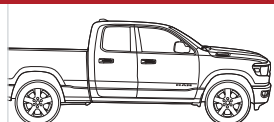

QUAD CAB®

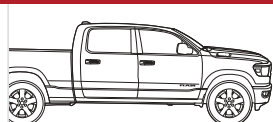

CREW CAB

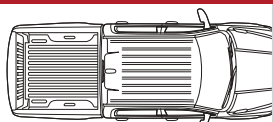

5' 7" BOX

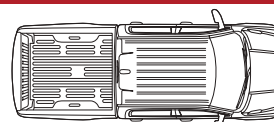

6' 4" BOX



40/20/40-SPLIT BENCH SEAT



BUCKET SEATS

TRADESMAN	•	•	CREW CAB	ALL CABS	S	N/A
BIG HORN / LONE STAR <sup>28</sup>	•	•	CREW CAB	ALL CABS	S	OPTIONAL
REBEL	•	•	CREW CAB	QUAD CAB	N/A	S
LARAMIE	•	•	CREW CAB	ALL CABS	S	OPTIONAL
LARAMIE LONGHORN	N/A	S	CREW CAB	CREW CAB	N/A	S
LIMITED	N/A	S	CREW CAB	CREW CAB	N/A	S

• = Available Configuration    N/A = Not Available    S = Standard Configuration

RAM 1500 INTERIOR FABRICS/COLORS



Vinyl Bench, Diesel Gray/Black  
Tradesman®



Cloth Bench, Black  
Optional on Tradesman



Cloth Bench/Bucket, Diesel Gray/Black  
Big Horn® / Lone Star<sup>28</sup>

Cloth Bench/Bucket, Light Mountain Brown/Black  
Big Horn / Lone Star<sup>28</sup>



Cloth Bench/Bucket, Black  
Big Horn / Lone Star<sup>28</sup>  
Big Horn / Lone Star<sup>28</sup> with Night Edition or Sport Appearance Package



Vinyl/Cloth Bucket, Black/Dark Ruby Red  
Rebel®

Leather-Trimmed Bucket, Black  
Rebel



Leather-Trimmed Bench/Bucket, Black  
Laramie® / Laramie with Night Edition or Sport Appearance Package

Leather-Trimmed Bench/Bucket, Light Frost Beige/Mountain Brown  
Laramie



Premium Leather Bucket, Cattle Tan/Black  
Laramie Longhorn®

Premium Leather Bucket, Light Mountain Brown/Mountain Brown  
Laramie Longhorn



Premium Leather Bucket with Laser Etching, Light Mountain Brown/Mountain Brown  
Laramie Longhorn



Premium Leather Bucket, Black  
Limited



Premium Leather Bucket, Light Frost Beige/Indigo  
Limited



# RAM 1500 EXTERIOR COLORS



Bright White



Ivory White Tri-Coat



Billet Silver



Maximum Steel Metallic



Granite Crystal



Diamond Black Crystal



Hydro Blue Pearl



Patriot Blue



Olive Green



Flame Red



Delmonico Red Pearl



RV Match Walnut Brown Metallic

## PAINT COLORS AND TWO-TONE OPTIONS

	Bright White	Ivory White	Billet Silver	Maximum Steel	Granite Crystal	Diamond Black Crystal	Hydro Blue	Patriot Blue	Olive Green	Flame Red	Delmonico Red Pearl	Walnut Brown
TRADESMAN®	M	N/A	M	M	M	M	M	M	M	M	M	M
BIG HORN® / LONE STAR <sup>2B</sup>	M	N/A	M	M	M	M	M	M	M	M	M	M
REBEL®	M/■	N/A	M/■	M/■	M/■	M	M/■	N/A	N/A	M/■	N/A	N/A
LARAMIE®	M	M/■	M	M/■	M/■	M/■	M/■	M/■	M/■	M/■	M/■	M/■
LARAMIE LONGHORN®	N/A	M/■	M/■	M/■	N/A	M/■	N/A	M/■	N/A	N/A	M/■	M/■
LIMITED	N/A	M	M	M	M	M	N/A	M	N/A	N/A	M	N/A



REBEL SHOWN IN FLAME RED WITH DIAMOND BLACK LOWER



LARAMIE SHOWN IN MAXIMUM STEEL METALLIC WITH BILLET SILVER LOWER



LARAMIE LONGHORN SHOWN IN IVORY WHITE TRI-COAT WITH RV MATCH WALNUT BROWN METALLIC LOWER

M = Available Monotone Color ■ = Diamond Black Lower ■ = Billet Silver Lower ■ = RV Match Walnut Brown Metallic Lower N/A = Not Available

TO SEE EXAMPLES OF ALL POSSIBLE PAINT COMBINATIONS, VISIT [RAMTRUCKS.COM](http://RAMTRUCKS.COM)

## RAM 1500 BUYER'S GUIDE

	Sales Code	Tradesman®	HFE	Big Horn® / Lone Star <sup>28</sup>	Rebel®	Laramie®	Laramie Longhorn®	Limited
<b>ENGINES / TRANSMISSIONS</b>								
3.6L Pentastar® V6 with eTorque / 8-speed Automatic	ERG/DFT	•	•	•	•	•	•	•
5.7L HEMI® V8 / 8-speed Automatic	EZH/DFR	0	–	0	0	0	0	0
5.7L HEMI V8 with eTorque / 8-speed Automatic	EZL/DFV	0	–	0	0	0	0	0
3.0L EcoDiesel V6 / 8-speed Automatic	EXH/DFV	0	–	0	0	0	0	0
<b>Body Model</b> – Quad Cab® 6' 4" box – 140.5-inch wheelbase (on Rebel models, only available as 4x4)	41	•	•	•	•	•	–	–
– Crew Cab 5' 7" box	98	0	–	0	0	0	•	•
– Crew Cab 6' 4" box	91	0	–	0	–	0	0	0
<b>Drive System</b> – 4x2	1	•	•	•	•	•	•	•
– 4x4	6	0	–	0	0	0	0	0
<b>MECHANICAL FEATURES</b>								
<b>Alternators</b> – 180-amp (included with 5.7L HEMI V8)	BAD	P	–	P	–	–	–	–
– 220-amp (included with 5.7L HEMI V8 if equipped with 400-watt inverter or RamBox® System)	BAJ	P	–	P	P	P	P	P
– 250-amp (included with 3.0L EcoDiesel V6)	BA7	P	–	P	P	P	P	P
<b>Rear Axle</b> – 3.21 ratio	DMC	•	•	•	–	•	•	•
– 3.55 ratio	DMD	•/0	–	0	–	0	0	0
– 3.92 ratio (included with Max Tow Package)	DMH	0/P	–	0/P	•	0/P	0	0
– Electronic locking differential – Available only on 3.92 axle ratio (included with Off-Road Group)	DSH	0/P	–	0/P	•	0/P	0/P	0/P
– Antispin differential	DSA	0	–	0	–	0	0	0
<b>Battery</b> – 730-amp	BCN	•	•	•	•	•	•	•
– 800-amp (included with 3.0L EcoDiesel V6)	BCF	P	–	P	P	P	P	P
<b>Engine Cooling</b> – Standard (included with 3.6L Pentastar V6)	NMB	•	–	•	•	•	•	•
– Heavy-duty (included with 5.7L HEMI V8 or 3.0L EcoDiesel V6)	NMC	P	–	P	P	P	P	P
<b>Fuel Fill</b> – Capless with secondary seal	XJM	•	•	•	•	•	•	•
<b>Fuel Tank</b> – 26-gallon (included with 5.7L HEMI V8 or 3.0L EcoDiesel V6 on Quad Cab models)	NFW	•/P	–	•/P	•/P	•/P	•	•
– 23-gallon (included with HFE models; standard with 3.6L Pentastar V6 Quad Cab; not available with 3.6L Pentastar V6 Crew Cab; included with 5.7L HEMI V8 with eTorque 4x4 Crew Cab short box on Tradesman, Big Horn / Lone Star; <sup>28</sup> Rebel and Laramie)	NF5	•/P	•	•/P	•/P	•/P	–	–
– 26-gallon (optional with H2, X2 and P2 Equipment Packages on 5.7L HEMI V8 with eTorque 4x4 Crew Cab short box on Big Horn / Lone Star; <sup>28</sup> Rebel and Laramie)	NG9	–	–	0	0	0	–	–
– 33-gallon (optional with H1, H2, X1, X2, P1 and P2 Equipment Packages)	NFF	0	–	0	0	0	0	0
<b>Grille Shutters</b> – Active	MDX	•	•	•	•	•	•	•
<b>Shock Absorbers</b> – Front, heavy-duty	SFB	•	•	•	–	•	•	•
– Off-road (included with Off-Road Group or North Edition)	SFD	P	–	P	–	P	P	P
– Bilstein® shocks	SFC	–	–	–	•	–	–	–
– Rear, heavy-duty	SGB	•	•	•	–	•	•	•
– Off-road (included with Off-Road Group or North Edition)	SGD	P	–	P	–	P	P	P
– Bilstein shocks	SGC	–	–	–	•	–	–	–
<b>Steering</b> – Electronic power (rack and pinion)	SBL	•	•	•	•	•	•	•
<b>Suspension</b> – Front, upper and lower A-arms, coil springs, twin-tube shocks	–	•	•	•	•	•	•	•
– Rear, five-link, coil springs, twin-tube shocks	–	•	•	•	•	•	•	•
– Active-Level™ Four-Corner Air Suspension System (optional with L1, H1, H2, X1, X2, P1 and P2 Equipment Packages; optional on Rebel 4x4 Crew Cab with X1 and X2 Equipment Packages with 5.7L HEMI V8 only)	SER	0	–	0	0	0	0	•
<b>Transfer Case</b> (4x4 only) – Electronic part-time	DH9	•	–	–	•	–	–	–
– Electronic on-demand	DH8	–	–	•	–	•	•	•
<b>EXTERIOR FEATURES</b>								
<b>Air Dam</b> – Fixed	MXA	•	•	•	•	•	•	•
– Active (not available with air suspension)	MXB	•	•	•	–	•	•	•
<b>Antenna</b> – Shark-fin (AM / FM / SXM <sup>10</sup> / GPS)	RD3/JLP	•	•	•	•	•	•	•

• = Standard. 0 = Optional. P = Part of Package. – = Not Available.



## RAM 1500 BUYER'S GUIDE

	Sales Code	Tradesman®	HFE	Big Horn®/ Lone Star®	Rebel®	Laramie®	Laramie Longhorn®	Limited
<b>EXTERIOR FEATURES (continued)</b>								
<b>Bed Rail Caps</b> – Black	–	•	•	•	•	•	•	•
<b>Bedliner</b> – Spray-in (included with Tradesman Group or Bed Utility Group)	XMF	P	–	P	0	P	•	•
– Spray-in Delete	XM9	–	–	–	–	–	0	0
<b>Bodyside Moldings</b> – Chrome	MJB	–	–	–	–	–	–	•
<b>Daylight Opening Moldings</b> – Black	–	•	•	•	•	•	–	–
– Chrome (included with Chrome Appearance Group on Laramie)	MMF	–	–	–	–	P	•	•
<b>Bumpers</b> – Front, Black	MB1	•	–	–	–	–	–	–
– Chrome (included with Chrome Appearance Group)	MCT	P	•	•	–	•	•	•
– Black powder-coated	MCS	–	–	–	•	–	–	–
– Painted lower accent color (included with two-tone paint)	MBU	–	–	–	–	P	P	–
– Painted body-color (included with Sport and Black Appearance Packages and Night Edition and North Edition)	MBP	P	–	P	–	P	P	P
– Rear, Black	MBN	•	–	–	–	–	–	–
– Chrome (included with Chrome Appearance Group)	MBF	P	•	•	–	•	•	•
– Rugged Black finish	MB5	–	–	–	•	–	–	–
– Painted body-color (included with Sport and Black Appearance Packages and Night Edition and North Edition)	MBQ	P	–	P	–	P	P	P
– Painted lower accent color (included with two-tone paint)	MBV	–	–	–	–	P	P	–
<b>Door Handles</b> – Black	MNA	•	•	–	–	–	–	–
– Body-color with chrome insert	MNE	–	–	•	–	•	•	•
– Body-color (included with Sport and Black Appearance Packages and Night Edition and North Edition)	MNK	–	–	P	•	P	–	P
<b>Exhaust</b> – Single	–	•	•	•	•	•	•	•
– Dual, bright tip (included with 5.7L HEMI® V8 or 3.0L EcoDiesel V6; not available with dual Black tip exhaust)	NER	–	–	P	–	P	P	P
– Dual, Black tip (included with 5.7L HEMI V8 or 3.0L EcoDiesel V6 on Black Appearance Package or Night Edition; included with 5.7L HEMI V8 or 3.0L EcoDiesel V6 on Rebel models)	NEP	P	–	P	P	P	–	P
<b>Fog Lamps</b> – Incandescent (included with Sport Appearance Package or Night Edition)	LNJ	P	–	•	–	–	–	–
– LED (included with Premium Lighting Group)	LNV	–	–	P	•	•	•	•
<b>Glass</b> – Tinted windows	GAC	•	•	•	•	•	•	•
– Privacy glass / deep-tint sunscreen (rear door)	GEG	•	•	•	•	•	•	•
– Acoustic laminated glass (front door)	GAQ	•	•	•	•	•	•	•
<b>Grille</b> – Black-surround, Black insert with chrome Ram letters	–	•	–	–	–	–	–	–
– Chrome-surround, Black insert with chrome Ram letters (included with Chrome Appearance Group)	–	P	•	–	–	–	–	–
– Chrome-surround, Black billet insert with chrome Ram letters	–	–	–	•	–	–	–	–
– Body-color-surround, Black billet insert with chrome Ram letters (included with Sport Appearance Package)	–	–	–	P	–	–	–	–
– Black-surround, Black billet insert with Black Ram letters (included with Black Appearance Package)	–	–	–	P	–	P	–	–
– Unique Black Rebel grille with painted Silver Ram letters	–	–	–	–	•	–	–	–
– Chrome-surround, chrome billet insert with chrome Ram letters	–	–	–	–	–	•	–	–
– Body-color-surround, chrome billet insert with chrome Ram letters (included with Sport Appearance Package)	–	–	–	–	–	P	–	–
– Unique Laramie Longhorn chrome-surround, chrome billet insert with chrome Ram letters	–	–	–	–	–	–	•	–
– Unique Limited chrome-surround, chrome insert with chrome Ram letters	–	–	–	–	–	–	–	•
<b>Headlamps</b> – Halogen with bright internal bezels	LME	•	•	•	–	–	–	–
– Halogen with dark internal bezels (included with Night Edition)	MFA	P	–	P	–	–	–	–
– Mid-level LED headlamp with signature bright internal bezels (included with Premium Lighting Group)	LPX	–	–	P	–	•	–	–
– Mid-level LED headlamp with signature dark internal bezels (included with Night Edition and Premium Lighting Group)	MFA	–	–	P	•	P	–	–
– Full LED headlamp with signature lighting	LM6	–	–	–	–	–	•	•
– Automatic (day / night sensor)	LMG	•	•	•	•	•	•	•
– Automatic high-beams (included with P1 and P2 Equipment Packages, Safety and Convenience Group and Advanced Safety Group)	LMS	–	–	–	P	P	•	•
<b>Sport Performance Hood</b> (included with Sport and Black Appearance Packages and Night Edition)	MGB	–	–	–	•	P	–	P

• = Standard. 0 = Optional. P = Part of Package. – = Not Available.

## RAM 1500 BUYER'S GUIDE

	Sales Code	Tradesman®	HFE	Big Horn® / Lone Star <sup>28</sup>	Rebel®	Laramie®	Laramie Longhorn®	Limited
<b>EXTERIOR FEATURES (continued)</b>								
<b>Lighting</b> – Cargo box illumination	LPE	•	•	•	•	•	•	•
– Bed lighting (included with tonneau cover and Bed Utility Group)	LPL	P	P	P	P	P	•	•
<b>Mirrors, Exterior</b> – 6 x 9-inch, powered, Black, manual-folding, heated, convex wide-angle insert (standard on Quad Cab® and Crew Cab)	GT6	•	•	•	•	–	–	–
– 6 x 9-inch, powered, Black, power-folding, heated, auto-dimming, convex wide-angle insert; includes exterior courtesy lamps and supplemental turn signal (included with H1, H2, X1 and X2 Equipment Packages)	GUK	–	–	P	P	–	–	–
– 6 x 9-inch, powered, chrome, power-folding, heated, auto-dimming, multifunctional, convex wide-angle insert; includes exterior courtesy lamps, supplemental turn signal and position memory	GU4	–	–	–	–	•	•	•
– 6 x 9-inch, powered, body-color, power-folding, heated, auto-dimming, multifunctional, convex wide-angle insert; includes exterior courtesy lamps, supplemental turn signal and position memory included on Laramie class only (included with Sport and Black Appearance Packages, Night Edition and North Edition)	GT5	•	–	P	–	P	–	P
– 7 x 11-inch trailer-tow, powered, Black, manual-folding; includes exterior courtesy lamps and supplemental turn signal (included with Trailer-Tow Group and Max Tow Package)	GPG	P	–	P	P	–	–	–
– 7 x 11-inch trailer-tow, powered, chrome, heated, multifunctional; includes exterior courtesy lamps, supplemental turn signal and position memory (included with Trailer-Tow Group and Max Tow Package)	GPC	–	–	–	–	P	P	P
<b>Paint</b> – Monotone (included with Black Appearance Package)	APA	•	•	•	O/P	•	•	•
– Two-tone	APD	–	–	–	•	O	O	–
<b>Skid Plates</b> – Front suspension (included with Protection Group and Off-Road Group)	XEU	P	–	P	•	P	P	P
– Transfer case (included with Protection Group and Off-Road Group)	XEF	P	–	P	•	P	P	P
– Electronic power steering (included with Protection Group and Off-Road Group)	XJ2	P	–	P	•	P	P	P
– Fuel tank (included with Protection Group and Off-Road Group)	XEE	P	–	P	•	P	P	P
<b>Steps / Running Boards</b> – Black side running boards, cab-length (Mopar®; optional with L1 Package, optional with H1 and H2 Equipment Packages with Night Edition, X1 and X2 Equipment Packages, and P2 Equipment Package with Night Edition)	MRU	O	–	O	O	P	–	–
– Chrome side steps, wheel-to-wheel (optional with H1, H2, P1 and P2 Equipment Packages; included with Chrome Appearance Group on Laramie; not available with Night Edition)	MRA	–	•	O	–	O/P	•	–
– Running boards, fixed, lower two-tone color (Mopar)	MRM	–	–	–	–	–	P	–
– Running boards, power-operated (optional with P2 Equipment Package; included with R1 Equipment Package)	MR7	–	–	–	–	O	P	•
– Bed step, deployable (included with Bed Utility Group)	MDN	P	–	P	P	P	P	P
<b>Storage</b> – RamBox® System (available with 5' 7" box only; optional with L1, H1, H2, X1, X2, P1 and P2 Equipment Packages)	XB9	O	–	O	O	O	O	O
– Bed divider (included with Bed Utility Group)	CKX	P	–	P	P	P	P	P
<b>Tailgate</b> – Standard, locking	XJJ	•	•	•	•	•	•	•
– Tailgate-ajar switch (included with P1 and P2 Equipment Packages)	LAN	–	–	•	•	P	•	•
– Fully damped / assisted tailgate (included with H2 Equipment Package or multifunction tailgate)	MWD	–	–	P	•	•	•	•
– Power-release tailgate (included with Comfort and Convenience Group and P1 and P2 Equipment Packages)	JKR	–	–	–	P	P	•	•
– Multifunction tailgate (requires spray-in bedliner; requires L1 and H1 Equipment Packages for Tradesman and Big Horn / Lone Star <sup>28</sup> )	MWK	O	–	O	O	O	O	O
<b>Taillamps</b> – Incandescent with bright internal bezel	LA6	•	•	•	–	–	–	–
– Incandescent with dark internal bezel (included with Night Edition)	LA6	P	–	P	–	–	–	–
– Premium LED with opaque Light Red lens in front of blind spot sensor area (included with Premium Lighting Group)	LAY	–	–	P	–	•	•	•
– Premium LED with opaque Dark Red lens in front of blind spot sensor area (included with Premium Lighting Group when included with Night Edition)	LAY	–	–	P	•	P	–	–
<b>Tie-downs</b> – Lower, fixed (four)	CKT	•	–	•	•	•	•	•
<b>Tires</b> – LT18-inch OWL On- / Off-Road (included with Off-Road Group; included with Max Tow Package)	TCP	P	–	P	–	P	–	–
– P18-inch BSW All-Season	TUM	–	–	•	–	•	–	–
– P18-inch BSW All-Season	TUL	•	–	O	–	–	–	–
– P20-inch OWL All-Season (included with Sport Appearance Package on Laramie; included with optional 20-inch wheel on Laramie; included with Night Edition; included with Sport Appearance Package on Big Horn / Lone Star <sup>28</sup> )	TUB	–	–	P	–	P	O	O
– P20-inch BSW All-Season	TTG	–	–	O	–	–	•	•
– P20-inch BSW All-Season	TTH	O	•	O	–	–	–	–
– LT18-inch OWL On- / Off-Road	TT6	–	–	–	•	–	–	–

• = Standard. O = Optional. P = Part of Package. – = Not Available.



## RAM 1500 BUYER'S GUIDE

	Sales Code	Tradesman®	HFE	Big Horn®/ Lone Star®28	Rebel®	Laramie®	Laramie Longhorn®	Limited
<b>EXTERIOR FEATURES (continued)</b>								
– P22-inch BSW All-Season (included with 22-inch wheel offerings)	TY4	–	–	–	–	P	P	P
– P20-inch OWL All-Terrain (included with Off-Road Group)	TTQ	P	–	P	–	P	P	P
– Full-size spare temporary-use	TBS	•	•	•	–	•	•	•
– Full-size spare (included with Off-Road Group)	TBB	P	–	P	•	P	P	P
<b>Tonneau Cover</b> – Tri-fold, soft; includes bed lighting (included with Black Appearance Package)	CS7	0	•	0	0	0	0	0/P
<b>Tow Hooks</b> – Front, Black (included with Protection Group, Off-Road Group and Black Appearance Package)	XEA	P	–	P	•	P	–	P
– Front, chrome (included with Chrome Appearance Group)	XHQ	–	–	–	–	P	•	•
<b>Trailer Tow</b> – 4- / 7-pin connector	XFK	•	•	•	•	•	•	•
– Class III hitch (bumper; not available with Class IV hitch receiver)	XFJ	•	•	•	–	–	–	–
– Class IV hitch receiver (included with H1 and H2 Equipment Packages, Tradesman Group, Trailer-Tow Group and Max Tow Package)	XFH	0/P	–	P	•	•	•	•
<b>Wheels</b> – 18 x 7.5-inch painted steel	WBF	•	–	–	–	–	–	–
– 18 x 8-inch painted aluminum (included with Chrome Appearance Group or Sport Appearance Package on Tradesman; included with Max Tow Package)	WBB	P	–	•	–	P	–	–
– 18 x 8-inch Black-painted / polished aluminum	WBT	–	–	–	•	–	–	–
– 18 x 8-inch Black-painted aluminum (included with Black Appearance Package)	WBS	–	–	–	P	–	–	–
– 18 x 8-inch painted aluminum	WBC	–	–	–	–	•	–	–
– 20 x 9-inch polished / painted aluminum (optional with Sport Appearance Package or Night Edition)	WRF	0	–	–	–	–	–	–
– 20 x 9-inch Black-painted aluminum (included with Night Edition on Tradesman; included with Night Edition or Black Appearance Package if equipped with Off-Road Group)	WRW	P	–	–	–	P	–	P
– 20 x 9-inch chrome-clad aluminum	WRK	–	–	0	–	–	–	–
– 20 x 9-inch premium chrome-clad aluminum	WRD	–	•	0	–	–	–	–
– 20 x 9-inch Black-painted aluminum (included with Night Edition)	WRP	–	–	P	–	–	–	–
– 20 x 9-inch premium painted / polished aluminum	WRB	–	–	–	–	0	–	–
– 20 x 9-inch premium painted / polished / insert aluminum (included with Sport Appearance Package)	WRJ	–	–	–	–	P	–	–
– 20 x 9-inch polished / Gray-painted aluminum	WRU	–	–	–	–	–	•	–
– 20 x 9-inch polished / Brown-painted aluminum (included with two-tone paint)	WRC	–	–	–	–	–	P	–
– 20 x 9-inch polished aluminum with accent-painted inserts	WRR	–	–	–	–	–	–	•
– 22 x 9-inch Black-painted / polished aluminum (optional with Sport Appearance Package)	WPM	–	–	–	–	0	–	–
– 22 x 9-inch Black-painted aluminum (included with Night Edition)	WPH	–	–	–	–	P	–	–
– 22 x 9-inch premium painted / Brown insert aluminum (optional with two-tone Laramie Longhorn)	WPF	–	–	–	–	–	0	–
– 22 x 9-inch premium painted / Gray insert aluminum (optional with monotone Laramie Longhorn)	WPZ	–	–	–	–	–	0	0
– 22 x 9-inch Black-painted aluminum (included with Black Appearance Package)	WP9	–	–	–	–	–	–	P
<b>Wheels, Spare</b> – 18-inch, steel (included with all size base wheels)	WIC	•	–	•	•	•	•	•
– 18-inch, aluminum (included with 5.7L HEMI® V8 with eTorque 4x4 Crew Cab and 3.0L EcoDiesel V6 4x2 Crew Cab 5' 7" box)	WIF	–	•	P	P	P	P	P
<b>Wheel Well Liners</b> – Front	MHR	•	•	•	•	•	•	•
– Rear (optional with L1, H1, H2, X1, X2, P1 and P2 Equipment Packages)	MWH	0	–	0	0	0	•	•
<b>Wheel Flares</b> – Lower two-tone body-color (included with lower two-tone paint)	MRD	–	–	–	–	P	P	–
– Monotone body-color	MML	–	–	–	–	•	•	•
– Off-road	MMQ	–	–	–	•	–	–	–
<b>Windshield Wipers</b> – Variable / intermittent	JHA	•	•	•	•	•	•	•
– Rain-sensing (included with X2, P1 and P2 Equipment Packages)	JHC	–	–	–	P	P	•	•
<b>INTERIOR FEATURES</b>								
<b>Air Conditioning</b> – Manual Temperature Control	HAA	•	•	•	•	–	–	–
– Dual-Zone Automatic Temperature Control (included with H2 and X2 Equipment Packages; included with Uconnect® NAV radios)	HAF	–	–	P	P	•	•	•

• = Standard. 0 = Optional. P = Part of Package. – = Not Available.

## RAM 1500 BUYER'S GUIDE

	Sales Code	Tradesman®	HFE	Big Horn®/ Lone Star®	Rebel®	Laramie®	Laramie Longhorn®	Limited
<b>INTERIOR FEATURES (continued)</b>								
<b>Clusters</b> – Base - Four-gauge with 3.5-inch monochromatic display	JAE	•	•	•	-	-	-	-
– Medium - Four-gauge with 3.5-inch color display (included with H1 Equipment Package)	JAK	-	-	P	-	-	-	-
– Premium - Six-gauge with 7-inch color reconfigurable Driver Information Display; animation-capable (included with H2, X1 and X2 Equipment Packages; not available with Rebel, which has a unique Rebel cluster)	JAL	-	-	P	-	•	-	-
– Premium - Six-gauge with 7-inch color reconfigurable Driver Information Display; animation-capable (Rebel theme)	JY2	-	-	-	•	-	-	-
– Premium - Six-gauge with 7-inch color reconfigurable Driver Information Display; animation-capable (Laramie Longhorn theme)	JY3	-	-	-	-	-	•	-
– Premium - Six-gauge with 7-inch color reconfigurable Driver Information Display; animation-capable (Limited theme)	JY4	-	-	-	-	-	-	•
<b>Console, Floor</b> – Full console with sliding storage and wrapped lid (included with bucket seats)	CUF	-	•	P	-	-	-	-
– Full console with sliding storage and wrapped lid with embossed logo (included with bucket seats)	CUP	-	-	-	•	P	-	-
– Full console with sliding storage with bombay door and premium, wrapped, leather lid with hard badge	CM5	-	-	-	-	-	•	•
<b>Console, Overhead</b> – Base	CUN	•	•	•	•	-	-	-
– Premium (included with dual-pane sunroof)	CUS	-	-	P	P	•	•	•
<b>Cup Holders</b> – Two on front and two on rear of center console, with bucket seats	-	-	-	P	•	P	•	•
– Two, front of fold-down center seat with bench	-	•	•	•	-	•	-	-
– Two, rear-seat fold-out center armrest	-	-	-	•	•	•	•	•
<b>Keyless Enter 'n Go™</b> – Passive (included with X2 Equipment Package)	GXD	-	-	-	P	•	•	•
<b>Speed-Sensitive Power Locks</b> – Illuminated entry	JPH	•	•	•	•	•	•	•
<b>Flooring</b> – Vinyl	CKJ	•	-	-	-	-	-	-
– Carpet, base (included with L1 Equipment Package, Sport Appearance Package and Night Edition)	CKE	P	•	•	•	•	•	•
<b>Floor Mats, Front and Rear</b> – Carpet (included with L1 Equipment Package, Sport Appearance Package and Night Edition)	CLE	P	-	•	-	•	-	-
– Rubber with premium carpet inserts (Crew Cab only)	CLX	-	-	-	-	-	•	•
– Rubber (Quad Cab® and Crew Cab; Mopar®; included with North Edition)	CLF	0	-	0/P	-	0	-	-
– Rubber (Quad Cab and Crew Cab) – Rebel theme	CL3	-	-	-	•	-	-	-
<b>Lighting, Ambient</b> – Interior mirror switches	-	•	•	•	•	•	•	•
– Overhead console, LED (included with dual-pane sunroof)	LHJ	-	-	P	P	•	•	•
– Front door handles and map pockets, LED	-	-	-	-	-	•	•	•
– Rear door handles and map pockets, LED (Crew Cab only)	-	-	-	-	-	•	•	•
– Instrument-panel LED pipes	-	-	-	-	-	•	•	•
<b>Lighting, Courtesy</b> – Front map light, incandescent	LBA	•	•	•	•	-	-	-
– Front map light, LED (included with dual-pane sunroof)	LHJ	-	-	P	P	•	•	•
– Front footwell, incandescent	LBB	-	-	•	•	-	-	-
– Front footwell, LED	-	-	-	-	-	•	•	•
– Glove box lamp (included with H1 and H2 Equipment Packages)	LBC	-	-	P	•	•	•	•
– Rear dome lamp, incandescent	LCH	•	•	•	•	-	-	-
– Rear dome lamp, incandescent, switchable (included with H1 and X1 Equipment Packages)	LHE	-	-	P	P	-	-	-
– Rear dome lamp, LED, switchable	LCL	-	-	-	-	•	•	•
– Rear dome lamp, dual, LED, switchable (included with dual-pane sunroof)	LCA	-	-	P	P	P	P	P
– Rear footwell, LED (Crew Cab only)	-	-	-	-	-	•	•	•
<b>Memory</b> – Driver only; seat, exterior mirrors, power-adjustable pedals, radio presets (included with Comfort and Convenience Group)	LEQ	-	-	-	P	•	•	•
<b>Mirror, Interior Rearview</b> – Manual day / night	GNA	•	•	•	•	-	-	-
– Automatic dimming day / night (included with H1, H2, X1 and X2 Equipment Packages)	GNK	-	-	P	P	•	•	•
<b>Pedals</b> – Fixed	XAB	•	•	•	•	-	-	-
– Power-adjustable (included with H1, H2, X1 and X2 Equipment Packages)	XAB	-	-	P	P	-	-	-
– Power-adjustable with memory	XAM	-	-	-	-	•	•	•

• = Standard. 0 = Optional. P = Part of Package. - = Not Available.



## RAM 1500 BUYER'S GUIDE

	Sales Code	Tradesman®	HFE	Big Horn® / Lone Star®	Rebel®	Laramie®	Laramie Longhorn®	Limited
<b>INTERIOR FEATURES (continued)</b>								
Seats – Vinyl front bench seats – 40/20/40-split bench, four-way manual driver's (fore / aft, seatback recline), four-way manual passenger (fore / aft, seatback recline), four-way manual-adjustable head restraints <sup>32</sup> (up / down, fore / aft), outboard positions only; rear seats, full-length stadium-folding bench, outboard head restraints <sup>32</sup> manual dump feature	*TX	•	-	-	-	-	-	-
– Cloth front bench seats – 40/20/40-split bench, four-way manual driver's (fore / aft, seatback recline), four-way manual passenger (fore / aft, seatback recline), four-way manual-adjustable head restraints <sup>32</sup> (up / down, fore / aft), outboard positions only; rear seats, full-length stadium-folding bench, outboard head restraints <sup>32</sup> manual dump feature (included with L1 Equipment Package, Sport Appearance Package and Night Edition)	*V9	P	-	-	-	-	-	-
– Cloth front bucket seats – Four-way manual driver's (fore / aft, seatback recline), four-way manual passenger (fore / aft, seatback recline), four-way manual-adjustable head restraints <sup>32</sup> (up / down, fore / aft), outboard positions only; rear seats, full-length stadium-folding bench, outboard head restraints <sup>32</sup> manual dump feature	*C5	-	•	-	-	-	-	-
– Cloth front bench seats – 40/20/40-split bench, four-way manual driver's (fore / aft, seatback recline), four-way manual passenger (fore / aft, seatback recline), eight-way power driver's seat (fore / aft, up / down, cushion tilt, seatback recline; included with H1 and H2 Equipment Packages), four-way power driver lumbar (fore / aft, up / down; included with H1 and H2 Equipment Packages), four-way manual passenger (fore / aft, seatback recline), four-way manual-adjustable head restraints <sup>32</sup> (up / down, fore / aft), outboard positions only, map pocket (back of outboard seats); rear seats, 60/40 stadium-folding bench, outboard head restraints <sup>32</sup> manual dump feature	*E1	-	-	•	-	-	-	-
– Cloth front bucket seats – Eight-way power driver's seat (fore / aft, up / down, cushion tilt, seatback recline), four-way power driver lumbar (fore / aft, up / down), four-way manual passenger (fore / aft, seatback recline), four-way manual-adjustable head restraints <sup>32</sup> (up / down, fore / aft), outboard positions only, full-length floor console with two front and two rear cup holders, map pocket (back of outboard seats); rear seats, 60/40 stadium-folding bench, outboard head restraints <sup>32</sup> manual dump feature (optional with H1 and H2 Equipment Packages; included with Sport Appearance Package and Night Edition)	*T9	-	-	O/P	-	-	-	-
– Vinyl / cloth front bucket seats – Unique two-tone with new tread pattern and embroidery, eight-way power driver's seat (fore / aft, up / down, cushion tilt, seatback recline), four-way power driver lumbar (fore / aft, up / down), four-way manual passenger (fore / aft, seatback recline), four-way manual-adjustable head restraints <sup>32</sup> (up / down, fore / aft), outboard positions only, Ram's Head logo on inside surface, map pocket (back of outboard seats); rear seats are 60/40 stadium-folding bench, outboard head restraints <sup>32</sup> manual dump feature	*G7	-	-	-	•	-	-	-
– Leather-trimmed bucket seats – Eight-way power driver's / passenger seat (fore / aft, up / down, cushion tilt, seatback recline), four-way power driver / passenger lumbar (fore / aft, up / down), four-way manual-adjustable head restraints <sup>32</sup> (up / down, fore / aft), outboard positions only, map pocket (back of outboard seats); rear seats are 60/40 stadium-folding bench, outboard head restraints <sup>32</sup> manual dump feature [included with Rebel 12 Package]	*TL	-	-	-	O/P	-	-	-
– Leather-trimmed front bench seats – 40/20/40-split bench, eight-way power driver's seat (fore / aft, up / down, cushion tilt, seatback recline), eight-way power passenger seat (fore / aft, up / down, cushion tilt, seatback recline), four-way power driver lumbar (fore / aft, up / down), four-way power passenger lumbar (fore / aft, up / down), driver memory, heated outboard seating positions, ventilated outboard seating positions, heated steering wheel, four-way manual-adjustable head restraints <sup>32</sup> (up / down, fore / aft), outboard positions only, map pocket (back of outboard seats); rear seats, 60/40 stadium-folding bench (Quad Cab® and base Crew Cab only), 60/40 stadium-folding bench with manual recline and center 20-percent fold-down console (not available with Quad Cab; included with P1 and P2 Equipment Packages), outboard head restraints <sup>32</sup> manual dump feature, heated rear seat (three adjustment levels each; included with P2 Equipment Package)	*DP	-	-	-	-	•	-	-
– Leather-trimmed front bucket seats (optional with P1 and P2 Equipment Packages; included with Sport Appearance Package) – Front bucket seats, eight-way power driver's seat (fore / aft, up / down, cushion tilt, seatback recline), eight-way power passenger seat (fore / aft, up / down, cushion tilt, seatback recline), four-way power driver lumbar (fore / aft, up / down), four-way power passenger lumbar (fore / aft, up / down), driver memory, heated outboard seating positions, ventilated outboard seating positions, heated steering wheel, four-way manual-adjustable head restraints <sup>32</sup> (up / down, fore / aft), outboard positions only, full-length floor console with two front and two rear cup holders, map pocket (back of outboard seats); rear seats, 60/40 stadium-folding bench (Quad Cab only), 60/40 stadium-folding bench with manual recline and center 20-percent fold-down center console (Crew Cab only), outboard head restraints <sup>32</sup> manual dump feature, heated rear seat (three adjustment levels each; included with Sport Appearance Package and Night Edition)	*GJ	-	-	-	-	O/P	-	-

• = Standard. O = Optional. P = Part of Package. - = Not Available.

## RAM 1500 BUYER'S GUIDE

	Sales Code	Tradesman®	HFE	Big Horn® / Lone Star®	Rebel®	Laramie®	Laramie Longhorn®	Limited
<b>INTERIOR FEATURES (continued)</b>								
– Premium leather front bucket (filigree) seats – Eight-way power driver's seat (fore / aft, up / down, cushion tilt, seatback recline), eight-way power passenger seat (fore / aft, up / down, cushion tilt, seatback recline), four-way power driver lumbar (fore / aft, up / down), four-way power passenger lumbar (fore / aft, up / down), driver memory, heated outboard seating positions, ventilated outboard seating positions, heated steering wheel, four-way manual-adjustable head restraints <sup>32</sup> (up / down, fore / aft), outboard positions only, full-length floor console with two front and two rear cup holders, map pocket (back of outboard seats); rear seats, 60/40 stadium-folding bench with manual recline and center 20-percent fold-down console, outboard head restraints <sup>32</sup> manual dump feature, heated rear seat (three adjustment levels each), ventilated rear seat (three adjustment levels each; included with R1 Equipment Package)	*XJ	–	–	–	–	–	•	–
– Premium leather front bucket (non-filigree) seats – Eight-way power driver's seat (fore / aft, up / down, cushion tilt, seatback recline), eight-way power passenger seat (fore / aft, up / down, cushion tilt, seatback recline), four-way power driver lumbar (fore / aft, up / down), four-way power passenger lumbar (fore / aft, up / down), driver memory, heated outboard seating positions, ventilated outboard seating positions, heated steering wheel, four-way manual-adjustable head restraints <sup>32</sup> (up / down, fore / aft), outboard positions only, full-length floor console with two front and two rear cup holders, map pocket (back of outboard seats); rear seats, 60/40 stadium-folding bench with manual recline and center 20-percent fold-down console, outboard head restraints <sup>32</sup> manual dump feature, heated rear seat (three adjustment levels each), ventilated rear seat (three adjustment levels each; included with R1 Equipment Package)	*DJ	–	–	–	–	–	0	–
– Premium leather front bucket seats – Eight-way power driver's seat (fore / aft, up / down, cushion tilt, seatback recline), eight-way power passenger seat (fore / aft, up / down, cushion tilt, seatback recline), four-way power driver lumbar (fore / aft, up / down), four-way power passenger lumbar (fore / aft, up / down), driver memory, heated outboard seating positions, ventilated outboard seating positions, heated steering wheel, four-way manual-adjustable head restraints <sup>32</sup> (up / down, fore / aft), outboard positions only, full-length floor console with two front and two rear cup holders, map pocket (back of outboard seats); rear seats, 60/40 stadium-folding bench with manual recline and center 20-percent fold-down console, outboard head restraints <sup>32</sup> manual dump feature, heated rear seat (three adjustment levels each), ventilated rear seat (three adjustment levels each; included with M1 Equipment Package)	*DL	–	–	–	–	–	–	•
<b>Shifter</b> – Rotary	–	•	•	•	•	•	•	•
– Black	CIG	P	P	P	–	–	–	–
– Bright	CIH	–	–	–	P	P	P	P
<b>Sill Plates</b> – Door sill scuff plates (plastic)	CLP	•	•	•	•	–	–	–
– Door sill scuff plates (metal)	CLT	–	–	–	–	•	•	•
<b>Speed Control</b> – Cruise control	NHM	•	•	•	•	•	•	•
– Adaptive Cruise Control with Stop & Go <sup>7</sup> (included with Advanced Safety Group, Safety and Convenience Group and M1 Equipment Package)	NHZ	–	–	–	P	P	P	P
<b>Start</b> – Keyless push-button	GX4	•	•	•	•	•	•	•
<b>Steering Column</b> – Manual tilt / telescoping	SUD	•	•	•	•	•	•	•
<b>Steering Wheel</b> – Urethane	SCA	•	•	–	–	–	–	–
– Leather-wrapped	SCV	–	–	•	–	•	–	–
– Leather-wrapped, perforated, accent stitching and Chrome-color bezels	SCB	–	–	–	•	–	–	–
– Leather-wrapped, real-wood	SCW	–	–	–	–	–	•	•
– Heated (included with H2 Equipment Package and X1 Equipment Package)	NHS	–	–	P	P	•	•	•
– Button controls – Driver Information Display	–	•	•	•	•	•	•	•
– Button controls – Cruise control	–	•	•	•	•	•	•	•
– Button controls – Bluetooth® / hands-free <sup>23</sup>	–	•	•	•	•	•	•	•
– Button controls – Adaptive Cruise Control with Stop & Go <sup>7</sup>	–	–	–	–	–	P	P	P
– Dual-note electric horns	JJB	•	•	•	•	•	•	•
– Electronic Range Select	–	•	•	•	•	•	•	•
<b>Storage</b> – Center stack pull-out drawer (bench seats only)	–	•	–	•	–	•	–	–
– Front-center underseat bin (bench seats only; included with *V9 seats)	CVH	P	–	•	–	•	–	–
– Front-seat-center seatback bin (bench seat only)	–	•	–	•	•	•	–	–
– Front-seat-center console bin (with bucket seats only)	CUF	–	•	P	•	P	•	•
– Rear in-floor bins with removable liners (Crew Cab only; included with L1 and H1 Equipment Packages)	CB9	P	–	P	•	•	•	•
– Rear underseat – Crew Cab only (included with X2 and P2 Equipment Packages; optional with H1, H2 and P1 Equipment Packages)	CUE	–	–	0	P	P/O	•	•

• = Standard. 0 = Optional. P = Part of Package. – = Not Available.



## RAM 1500 BUYER'S GUIDE

	Sales Code	Tradesman®	HFE	Big Horn® / Lone Star®	Rebel®	Laramie®	Laramie Longhorn®	Limited
<b>INTERIOR FEATURES (continued)</b>								
<b>Sunroof</b> – Single-pane, power-operated (Quad Cab® only; optional with H2, X2, P1 and P2 Equipment Packages)	GWA	-	-	0	0	0	-	-
– Dual-pane, power-operated (Crew Cab only; optional with H2, X2, P1 and P2 Equipment Packages)	GWJ	-	-	0	0	0	0	0
<b>Sun Visor</b> – Passenger-side with mirror	GNE	•	-	-	-	-	-	-
– Passenger-side with mirror and light	GN6	-	•	•	•	-	-	-
– Driver's-side with mirror and light (included with H1 and X1 Equipment Packages) with Universal Garage Door Opener (included with H1, H2, X1 and X2 Equipment Packages)	GNC	-	-	P	P	•	•	•
– Cloth driver / passenger with mirror	-	•	•	•	•	•	•	•
<b>Turn Signals</b> – Three-blink lane change feature	-	•	•	•	•	•	•	•
<b>Window Control</b> – Windows, power one-touch up / down, driver and front-passenger	JP3	•	•	•	•	•	•	•
– Rear backlight, fixed	GJD	•	•	-	-	-	-	-
– Rear backlight, manual-sliding	GFD	-	-	•	-	-	-	-
– Rear backlight, power-sliding (included with L1, H1 and H2 Equipment Packages)	GFE	P	-	P	•	•	•	•
– Rear defroster (with power-sliding backlight only; included with H1, H2, X1 and X2 Equipment Packages)	GFA	-	-	P	P	•	•	•
<b>UCONNECT® MULTIMEDIA</b>								
<b>Uconnect Integrated Voice Command</b> – With Bluetooth®	XRB	•	•	•	•	•	•	•
– Front: two 2.5A USB ports – fully functional	RSF	•	•	•	•	•	•	•
– Middle: one 2.5A USB port – charging-only (included with bench and bucket seats)	RS3	•	•	•	•	•	•	•
– Rear: one 2.5A USB port – fully functional (included with H2 and X2 Equipment Packages)	RS4	-	-	P	P	•	•	•
– Rear: one 2.5A USB port – charging-only (included with H2 and X2 Equipment Packages)	RS4	-	-	P	P	•	•	•
– Front – auxiliary headphone jack	RSU	•	•	•	•	•	•	•
<b>Power</b> – Accessory delay	JKY	•	•	•	•	•	•	•
– Front seat, 12-volt ignition-fed	JJJ	•	•	•	•	•	•	•
– Front seat, 115-volt outlet (three-prong), battery-fed (optional with L1 Equipment Package; included with H2 Equipment Package)	JKV	0	-	P	•	•	•	•
– Rear seat, 115-volt outlet (three-prong), battery-fed (included with H2 and X2 Equipment Packages)	JJN	-	-	P	P	•	•	•
– RamBox® Cargo Management System, 115-volt outlet (three-prong), battery-fed (included with RamBox System)	-	P	-	P	P	P	P	P
– Front seat, wireless charging pad (available with bucket seats only; included with Comfort and Convenience Group and P2 and R1 Equipment Packages)	RFX	-	-	-	P	P	P	•
– 400-watt inverter (included with H2 Equipment Package and RamBox System)	XHR	P	-	P	•	•	•	•
<b>Systems</b> – Uconnect 3 with 5-inch display	UAA	•	•	•	•	-	-	-
– Uconnect 4 with 8.4-inch display (included with H1, H2, X1 and X2 Equipment Packages)	UAM	-	-	P	P	•	-	-
– Uconnect 4C NAV with 8.4-inch display (optional with H1, H2, X1 and X2 Equipment Packages; included with P2 Equipment Package)	UAV	-	-	0	0	0/P	•	-
– Uconnect 4C NAV with 12-inch display (optional with H2 and X2 Equipment Packages; included with Rebel 12 Package and R1 Equipment Package)	UAX	-	-	0	0/P	0	P	•
<b>Radio Controls</b> – Steering wheel-mounted	RDZ	-	-	•	•	•	•	•
<b>SiriusXM® Radio<sup>18</sup></b> (1-year trial) – Included with L1, H1 and H2 Equipment Packages	RSD	P	P	P	•	•	•	•
<b>SiriusXM Traffic Plus<sup>18</sup></b> (5-year trial) – Included with Navigation radios	RTB	-	-	P	P	P	•	•
<b>SiriusXM Travel Link<sup>18,21</sup></b> (5-year trial) – Included with Navigation radios	RSM	-	-	P	P	P	•	•
<b>Sound System</b> – Six-speaker	RCG	•	•	•	•	-	-	-
– Alpine® 10-speaker system (included with Rebel 12 Package; optional with H1, H2, X1 and X2 Equipment Packages)	RC3	-	-	0	0/P	•	•	•
– Harman Kardon® 19-speaker system (included with Rebel 12 Package, P2, R1 and M1 Equipment Packages and Black Appearance Package; not available with Quad Cab)	RCA	-	-	-	P	P	P	P
<b>SiriusXM Guardian™<sup>20</sup> Connected Services</b> (1-year trial) – Built-in cellular connection (included with UAV and UAX radios)	RSK	-	-	P	P	P	P	P
<b>Uconnect Features</b> – Power side step personalization (included with power side steps)	-	-	-	-	-	P	P	P
– Apple CarPlay® <sup>3</sup> / Android Auto™ <sup>19</sup> (included with 8.4-inch and 12-inch radios)	RFP/RF5	-	-	P	P	•	•	•
– Active Noise Cancellation (included on 5.7L HEMI® V8 engines)	JLW	P	-	P	P	P	P	P

• = Standard. 0 = Optional. P = Part of Package. - = Not Available.

## RAM 1500 BUYER'S GUIDE

	Sales Code	Tradesman®	HFE	Big Horn® / Lone Star <sup>28</sup>	Rebel®	Laramie®	Laramie Longhorn®	Limited
<b>SAFETY &amp; SECURITY</b>								
<b>Air Bags<sup>5</sup></b> – Advanced multistage driver and front-passenger	CG3	•	•	•	•	•	•	•
– Supplemental side-curtain	CGS	•	•	•	•	•	•	•
– Supplemental side seat	CJ1	•	•	•	•	•	•	•
<b>Belt Alert</b> – Driver	LAX	•	•	•	•	•	•	•
– Passenger	LAX	•	•	•	•	•	•	•
<b>Brakes</b> – Power-assisted 4-wheel antilock disc	BRT	•	•	•	•	•	•	•
– Brake override	–	•	•	•	•	•	•	•
<b>Electronic Parking Brake</b>	XC4	•	•	•	•	•	•	•
<b>Electronic Stability Control (ESC)<sup>30</sup></b>	BNB	•	•	•	•	•	•	•
– Brake Assist	BGE	•	•	•	•	•	•	•
– Electronic Roll Mitigation	BNS	•	•	•	•	•	•	•
– Hill Start Assist	BNG	•	•	•	•	•	•	•
– Rain Brake Support	BHC	•	•	•	•	•	•	•
– Ready Alert Braking	BHD	•	•	•	•	•	•	•
– All-Speed Traction Control	BNM	•	•	•	•	•	•	•
– Trailer Sway Damping <sup>33</sup>	BNT	•	•	•	•	•	•	•
<b>Hill Descent Control</b> (included with Off-Road Group and North Edition)	BNH	P	–	P	•	P	P	P
<b>Camera</b> – ParkView® Rear Back-Up Camera <sup>10</sup> with dynamic grid lines and center lines	XAC	•	•	•	•	•	•	•
– 360° Surround-View Camera System <sup>10</sup> (included with Advanced Safety Group and M1 Equipment Package)	XAK	–	–	–	–	P	P	P
<b>Blind Spot Monitoring<sup>9</sup> with Rear Cross-Path and Trailer Detection<sup>10</sup></b> (optional with L1, H2 and X2 Equipment Packages; requires Premium Lighting Group on Big Horn / Lone Star <sup>28</sup> ; included with P1, P2 and R1 Equipment Packages)	XAN	0	–	0	0	P	P	•
<b>Forward Collision Warning<sup>8</sup></b> – Adaptive emergency braking (included with Safety and Convenience Group, M1 Equipment Package and Advanced Safety Group)	LSU	–	–	–	P	P	P	P
<b>LaneSense® Lane Departure Warning Plus<sup>6</sup></b> (included with Safety and Convenience Group, M1 Equipment Package and Advanced Safety Group)	LAS	–	–	–	P	P	P	P
<b>Head Restraints<sup>32</sup></b> – Front – Outboard, four-way manual-adjustable (up / down, fore / aft)	CDP	•	•	•	•	•	•	•
– Rear – Manual dump feature on outboard seating positions	CSH	•	•	•	•	•	•	•
<b>ParkSense® Front and Rear Park Assist with Rear ParkSense Stop<sup>31</sup></b> (optional with H1 and X1 Equipment Packages; included with H2, X2, P2 and P1 Equipment Packages)	XH4	–	–	0/P	0/P	0/P	•	•
<b>Parallel and Perpendicular Park Assist<sup>31</sup></b> (included with Advanced Safety Group and M1 Equipment Package)	XH5	–	–	–	–	P	P	P
<b>Remote Keyless Entry</b> – Controls for power locks (including doors, tailgate and RamBox® Cargo Management System when so equipped) – Illuminated entry system, panic alarm; includes two transmitters (included with L1 Equipment Package)	GXM	•	•	•	•	•	•	•
<b>Remote Start System<sup>17</sup></b> – Key fob activation (optional; included with H2 and X2 Equipment Packages)	XBM	–	–	0/P	0/P	•	•	•
<b>Restraints</b> – Front, three-point seat belts, shoulder height-adjustable (outboard seating positions)	CGD	•	•	•	•	•	•	•
– Front, three-point seat belts (center seating position, bench only)	–	•	•	•	–	•	–	–
– Rear, three-point seat belts (all seating positions)	–	•	•	•	•	•	•	•
<b>LATCH</b> – Child Seat Anchor System	CGU	•	•	•	•	•	•	•
– Occupant Classification System	–	•	•	•	•	•	•	•
<b>Security</b> – Sentry Key® engine immobilizer	GXX	•	•	•	•	•	•	•
– Security alarm <sup>34</sup> (included with H2 and X2 Equipment Packages)	LSA	–	–	P	P	•	•	•
<b>Tire Pressure Monitor (TPM)</b> – Tire-specific TPM display	XGM	•	•	•	•	•	•	•
– Tire-fill alert system	LAW	•	•	•	•	•	•	•
<b>Trailer Brake Controller</b> – Integrated electronic controller (requires Class IV trailer hitch receiver; included with Trailer-Tow Group and Max Tow Package)	XHC	0/P	–	0/P	0/P	0/P	0/P	0/P

• = Standard. 0 = Optional. P = Part of Package. – = Not Available.



## RAM 1500 BUYER'S GUIDE

	Sales Code	Tradesman®	HFE	Big Horn® / Lone Star <sup>28</sup>	Rebel®	Laramie®	Laramie Longhorn®	Limited
<b>APPEARANCE PACKAGES</b>								
<b>Chrome Appearance Group (Tradesman)</b> – Includes chrome front bumpers, chrome rear bumpers, chrome grille surround, 18-inch painted aluminum wheels and P18-inch BSW All-Season tires (optional with L1 Equipment Package)	AMP	0	-	-	-	-	-	-
<b>Chrome Appearance Group (Laramie)</b> – Includes monotone paint, chrome window moldings, chrome tow hooks and chrome wheel-to-wheel side steps (optional with P1 and P2 Equipment Packages only; not available with Sport or Black Appearance Packages)	AMP	-	-	-	-	0	-	-
<b>North Edition</b> – Includes Hill Descent Control, e-locker rear axle, body-color door handles, 4x4 decal, tow hooks, engine block heater, body-color exterior mirrors, rubber floor mats, body-color front and rear bumpers, body-color grille, front and rear extra-heavy-duty shocks, and LT275/65R18C OWL On- / Off-Road tires (Crew Cab 4x4 only)	ASP	-	-	0	-	-	-	-
<b>Sport Appearance Package (Tradesman)</b> – Includes monotone paint, body-color front and rear bumpers, body-color grille surround, 18-inch aluminum wheels, *V9 cloth bench seats, carpet floor covering, carpet floor mats and fog lamps (requires L1 Equipment Package)	AEF	0	-	-	-	-	-	-
<b>Sport Appearance Package (Big Horn / Lone Star<sup>28</sup>)</b> – Includes monotone paint only, body-color front bumper, body-color rear bumper, body-color grille surround, body-color door handles, body-color mirror cap and cloth bucket seats (optional with H1 or H2 Equipment Packages)	AEF	-	-	0	-	-	-	-
<b>Sport Appearance Package (Laramie)</b> – Includes monotone paint only, body-color front bumper, body-color rear bumper, body-color grille surround, body-color door handles, body-color mirror caps, Sport Performance Hood, 20 x 9-inch cast aluminum premium paint / polished / insert wheels, P20-inch OWL All-Season tires, leather-trimmed bucket seats, optional 22 x 9-inch forged aluminum polished premium paint wheels (with P2 Equipment Package only) and optional P22-inch BSW All-Season tires (packaged with optional 22-inch wheel; optional with P1 and P2 Equipment Packages; not available with Chrome Appearance Group)	AEF	-	-	-	-	0	-	-
<b>Night Edition (Tradesman)</b> – Includes monotone paint, 20-inch Black-painted aluminum wheels, Black grille, Black badges, dual Black exhaust tips (packaged with 5.7L HEMI® V8 or 3.0L EcoDiesel V6), and headlamps and taillamps with dark internal bezels (includes Sport Appearance Package; requires L1 Equipment Package)	ASH	0	-	-	-	-	-	-
<b>Night Edition (Big Horn / Lone Star<sup>28</sup>)</b> – Includes monotone paint, Black grille, 20 x 9-inch cast aluminum Black-painted wheels, Black badges, Black exhaust tips, dual (packaged with 5.7L HEMI V8 or 3.0L EcoDiesel V6), and headlamps and taillamps with dark internal bezels (includes Sport Appearance Package; optional with H2 Equipment Package only)	ASH	-	-	0	-	-	-	-
<b>Night Edition (Laramie)</b> – Includes monotone paint, Black grille, 22 x 9-inch forged aluminum Black-painted wheels, Black badges, dual Black exhaust tips (packaged with 5.7L HEMI V8 or 3.0L EcoDiesel V6), and headlamps and taillamps with dark internal bezels (includes Sport Appearance Package; optional with P2 Equipment Package only; not available with Chrome Appearance Group)	ASH	-	-	-	-	0	-	-
<b>Black Appearance Package (Rebel)</b> – Includes Black monotone paint, 18-inch Black-painted aluminum wheels, Black grille, and Black front bumper and skid plate	ALC	-	-	-	0	-	-	-
<b>Black Appearance Package (Limited)</b> – Includes Black exterior paint, Black grille, Black door handles and mirror caps, Black front and rear bumpers, Sport Performance Hood, tri-folding tonneau cover, Black tow hooks, 22-inch Black-painted aluminum wheels, dual Black exhaust tips (packaged with 5.7L HEMI V8 or 3.0L EcoDiesel V6), Black badges, Black window moldings, headlamps and taillamps with dark internal bezels, 19-speaker premium audio system and Black interior	ALC	-	-	-	-	-	-	0
<b>EQUIPMENT PACKAGES</b>								
<b>Tradesman Level 1 Equipment Package (L1)</b> – Includes power-sliding rear backlight, cloth 40/20/40-split bench seat, rear in-floor storage bins, carpet floor covering, carpet floor mats and SiriusXM® Radio <sup>19</sup> (optional: vinyl floor covering)	A61	0	-	-	-	-	-	-
<b>Big Horn / Lone Star<sup>28</sup> Level 1 Equipment Package (H1)</b> – Includes switchable rear dome lamp, glove box lamp, upper closed glove box with painted hard door, auto-dimming interior rearview mirror, exterior power-folding mirrors with signal and puddle lamps, Universal Garage Door Opener, four-gauge with 3.5-inch color display, power-adjustable pedals, rear defroster, Uconnect® 4 with 8.4-inch display, power-sliding rear window, driver's-side sun visor mirror and light, rear in-floor storage bins, eight-way power driver's seat (fore / aft, up / down, cushion tilt, seatback recline), four-way power driver lumbar (fore / aft, up / down), foam bottle inserts (front doors only), SiriusXM Radio <sup>19</sup> Class IV hitch receiver and Big Horn / Lone Star <sup>28</sup> logo (on instrument panel)	A62	-	-	0	-	-	-	-
<b>Big Horn / Lone Star<sup>28</sup> Level 2 Equipment Package (H2) (includes H1 Equipment Package)</b> – Remote Start System, <sup>17</sup> security alarm, <sup>34</sup> ParkSense® Front and Rear Park Assist with Rear ParkSense Stop, <sup>31</sup> heated front seats, heated steering wheel, Dual-Zone Automatic Temperature Control; rear: one 2.5A USB port, fully functional, rear: one 2.5A USB port, charging-only; front seat: 115-volt outlet (three-prong), battery-fed, rear seat: 115-volt outlet (three-prong), battery-fed, 400-watt inverter, fully damped / assisted tailgate, 7-inch programmable cluster display and power-sliding rear window	A63	-	-	0	-	-	-	-

• = Standard. 0 = Optional. P = Part of Package. - = Not Available.

## RAM 1500 BUYER'S GUIDE

	Sales Code	Tradesman®	HFE	Big Horn® / Lone Star®	Rebel®	Laramie®	Laramie Longhorn®	Limited
<b>EQUIPMENT PACKAGES (continued)</b>								
<b>Rebel Level 1 Equipment Package (X1)</b> – Includes switchable rear dome lamp, auto-dimming interior rearview mirror, exterior power-folding mirrors with signal and puddle lamps, Universal Garage Door Opener, power-adjustable pedals, heated front seats, heated steering wheel, rear defroster, Uconnect® 4 with 8.4-inch display, driver's-side sun visor mirror and light, and foam bottle inserts (front doors only)	A64	-	-	-	0	-	-	-
<b>Rebel Level 2 Equipment Package (X2) (includes X1 Equipment Package)</b> – Remote Start System, <sup>17</sup> Keyless Enter 'n Go™ security alarm, <sup>34</sup> rain-sensing windshield wipers, ParkSense® Front and Rear Park Assist with Rear ParkSense Stop, <sup>31</sup> Dual-Zone Automatic Temperature Control; rear: one 2.5A USB port, fully functional, rear: one 2.5A USB port, charging-only, rear seat: 115-volt outlet (three-prong), battery-fed and rear underseat storage (Crew Cab only)	A65	-	-	-	0	-	-	-
<b>Laramie Level 1 Equipment Package (P1)</b> – Includes Auto High-Beam Headlamp Control, rain-sensing windshield wipers, Blind Spot Monitoring <sup>9</sup> with Rear Cross-Path and Trailer Detection, <sup>10</sup> foam bottle inserts (front doors only), tailgate-ajar switch, power-release tailgate, 60/40 stadium-folding rear bench with manual recline and center 20-percent fold-down console (not available with Quad Cab®), and ParkSense Front and Rear Park Assist with Rear ParkSense Stop <sup>31</sup>	A66	-	-	-	-	0	-	-
<b>Laramie Level 2 Equipment Package (P2)</b> – Includes P1 Equipment Package, Uconnect 4C NAV, wireless charging pad (available with bucket seats only), premium plus sound system, heated rear seat (three adjustment levels each) and rear underseat storage (Crew Cab models only)	A67	-	-	-	-	0	-	-
<b>Laramie Longhorn Level 1 Equipment Package (R1)</b> – Includes wireless charging pad, Blind Spot Monitoring <sup>9</sup> with Rear Cross-Path and Trailer Detection, <sup>10</sup> power-operated running boards, Uconnect 12-inch radio, rear-seat ventilation (three adjustment levels each) and premium plus sound system	A68	-	-	-	-	-	0	-
<b>Limited Level 1 Equipment Package (M1)</b> – Includes Adaptive Cruise Control with Stop & Go, <sup>7</sup> Forward Collision Warning, <sup>9</sup> LaneSense® Lane Departure Warning Plus, <sup>6</sup> 360° Surround-View Camera System, <sup>10</sup> Parallel and Perpendicular Park Assist, <sup>31</sup> ventilated rear seat (three adjustment levels each) and premium plus sound system	A69	-	-	-	-	-	-	0
<b>FUNCTIONAL PACKAGES / GROUPS</b>								
<b>Cold Weather Group</b> – Includes engine block heater and winter front grille cover (requires 3.0L EcoDiesel V6)	ADE	0	-	0	0	0	0	0
<b>Safety and Convenience Group</b> – Includes Auto High-Beam Headlamp Control, Forward Collision Warning, <sup>9</sup> Adaptive Cruise Control with Stop & Go <sup>7</sup> and LaneSense Lane Departure Warning Plus <sup>6</sup> (requires X2 Equipment Package)	AAU	-	-	-	0	-	-	-
<b>Comfort and Convenience Group</b> – Includes memory for driver's seat and mirrors, 12-way power adjust for driver's and passenger seats, wireless charging pad, remote tailgate release and heated rear seats (requires X1 or X2 Equipment Packages)	AFB	-	-	-	0	-	-	-
<b>Bed Utility Group</b> – Includes upper adjustable tie-downs, bed divider (available with RamBox® Cargo Management System only), bed lighting deployable bed step and spray-in bedliner (Big Horn / Lone Star <sup>28</sup> and Laramie models only; optional with L1, H1, H2, X1, X2, P1 and P2 Equipment Packages)	ANT	0	-	0	0	0	0	0
<b>Protection Group</b> – Includes tow hooks, front suspension skid plate, transfer case skid plate, electronic power steering skid plate and fuel tank skid plate (4x4 models only)	ADB	0	-	0	-	0	0	0
<b>Off-Road Group</b> – Includes tow hooks, front suspension skid plate, transfer case skid plate (on 4x4 models only), electronic power steering skid plate, fuel tank skid plate, rear electronic locking axle, front off-road calibrated shocks, rear off-road calibrated shocks, branded off-road shocks, front (Rebel only), branded off-road shocks, rear (Rebel only), Hill Descent Control, off-road decals (both sides, rear quarter panel, not included with Rebel), LT18-inch OWL On- / Off-Road tires, P20-inch OWL All-Terrain tires (on Laramie Longhorn and Limited; optional with 20-inch wheels on Big Horn / Lone Star <sup>28</sup> ) and full-size spare (optional with L1, H1 or H2 Equipment Packages; standard on all 4x2 and 4x4 Rebel models; not available with 4x2 non-Rebel models)	AWL	0	-	0	•	0	0	0
<b>Trailer-Tow Group</b> – Includes Class IV hitch receiver, integrated Trailer Brake Controller and 7 x 11-inch trailer-tow mirrors	AHC	0	-	0	0	0	0	0
<b>Advanced Safety Group</b> – Includes Adaptive Cruise Control with Stop & Go, <sup>7</sup> Forward Collision Warning, <sup>9</sup> LaneSense Lane Departure Warning Plus, <sup>6</sup> 360° Surround-View Camera System, <sup>10</sup> Auto High-Beam Headlamp Control and Parallel and Perpendicular Park Assist <sup>31</sup> (optional with P2 and R1 Equipment Packages)	ALP	-	-	-	-	0	0	-
<b>Tradesman Group</b> – Includes Class IV hitch receiver and spray-in bedliner	AS9	0	-	-	-	-	-	-
<b>Max Tow Package</b> – Includes max towing 10-inch axle with 3.92 axle ratio, Trailer-Tow Group, 18 x 8-inch aluminum wheels and LT18-inch OWL On- / Off-Road tires (available with 5.7L HEMI® V8 with eTorque or 3.0L EcoDiesel V6 4x2 Quad Cab only)	AJL/AJQ	0	-	0	-	0	-	-
<b>Premium Lighting Group</b> – Includes bi-LED projector headlamps with signature lighting, LED taillamps with signature lighting and LED fog lamps (optional with H2 Equipment Package only; required with Blind Spot Monitoring <sup>9</sup> on Big Horn / Lone Star <sup>28</sup> )	AD6	-	-	0	-	-	-	-
<b>Body-Color Bumper Group</b> – Includes body-color front bumper and body-color rear bumper	ALN	-	-	-	-	-	0	0
<b>Rebel 12 Package</b> – Includes leather-trimmed seating, premium sound system and Uconnect 12-inch radio	AZ5	-	-	-	0	-	-	-

• = Standard. 0 = Optional. P = Part of Package. - = Not Available.



# RAM 1500 SPECIFICATIONS

## RAM 1500 EXTERIOR DIMENSIONS

All dimensions are in inches (millimeters) unless otherwise noted.						
MODEL – TIRE SIZE	QUAD CAB® PICKUP		CREW CAB PICKUP			
	2WD – 275/55R20	4WD – 275/55R20	2WD – 275/55R20		4WD – 275/55R20	
BOX SIZE	6' 4"	6' 4"	5' 7"	6' 4"	5' 7"	6' 4"
WHEELBASE (NOMINAL)	140.5 (3569)	140.5 (3569)	144.6 (3672)	153.5 (3898)	144.6 (3672)	153.5 (3898)
TRACK, FRONT	68.5 (1741)	68.5 (1741)	68.5 (1741)	68.5 (1741)	68.5 (1741)	68.5 (1741)
TRACK, REAR	68.1 (1729)	68.1 (1729)	68.1 (1729)	68.1 (1729)	68.1 (1729)	68.1 (1729)
OVERALL LENGTH	228.9 (5814)	228.9 (5814)	232.9 (5916)	241.8 (6142)	232.9 (5916)	241.8 (6142)
OVERALL WIDTH	82.1 (2084)	82.1 (2084)	82.1 (2084)	82.1 (2084)	82.1 (2084)	82.1 (2084)
OVERALL HEIGHT	77.6 (1971)	77.7 (1973)	77.5 (1968)	77.4 (1966)	77.6 (1971)	77.5 (1968)
<b>GROUND CLEARANCE</b>						
FRONT AXLE	7.8 (199)	8.2 (208)	7.8 (199)	7.8 (199)	8.2 (209)	8.1 (207)
REAR AXLE	8.7 (221)	8.7 (221)	8.6 (220)	8.7 (220)	8.7 (220)	8.6 (220)
OPEN TAILGATE TO GROUND	34.6 (879)	34.4 (875)	34.5 (877)	34.4 (875)	34.3 (872)	34.3 (871)
PICKUP BODY HEIGHT	21.4 (545)	21.4 (545)	21.4 (543)	21.4 (545)	21.4 (543)	21.4 (545)
APPROACH ANGLE, degrees	18.1	18.9	18.0	18.1	19.0	18.9
DEPARTURE ANGLE, degrees	25.2	25.0	25.1	25.0	24.9	24.9
RAMP BREAKOVER ANGLE WITHOUT SKID PLATE, degrees	19.5	19.9	19.0	18.4	19.5	18.7
RAMP BREAKOVER ANGLE WITH SKID PLATE, degrees		17.8			17.5	16.7
GROUND CLEARANCE WITHOUT SKID PLATE	8.4 (213)	8.7 (221)	8.3 (211)	8.3 (212)	8.7 (222)	8.6 (220)
GROUND CLEARANCE WITH SKID PLATE		8.2 (208)			8.2 (209)	8.1 (207)

## MAXIMUM PAYLOAD CAPACITIES<sup>4</sup>

	GCWR <sup>1</sup>	QUAD CAB PICKUP		CREW CAB PICKUP			
		6' 4" Box		5' 7" Box		6' 4" Box	
		4x2	4x4	4x2	4x4	4x2	4x4
3.6L PENTASTAR® V6 eTORQUE/8-SPEED AUTO	6,010	1,200					
	6,800		1,810				
	6,900			2,000	1,810	1,960	1,770
	7,100	<b>2,300</b>					
3.0L ECODIESEL V6/8-SPEED AUTO	7,000			1,780		1,740	
	7,100		1,750				
	7,200	2,040			1,800		1,750
5.7L HEMI® V8/8-SPEED AUTO	6,900	1,900		1,810		1,770	
	7,100		1,910		1,840		1,790
5.7L HEMI V8 eTORQUE/8-SPEED AUTO	6,900	1,820		1,720		1,680	
	7,100		1,820		1,770		1,690

## MAXIMUM LOADED TRAILER WEIGHT<sup>4</sup>

	Axle Ratio	GCWR <sup>1</sup>	QUAD CAB PICKUP		CREW CAB PICKUP			
			6' 4" Box		5' 7" Box		6' 4" Box	
			4x2	4x4	4x2	4x4	4x2	4x4
3.6L PENTASTAR V6 eTORQUE/8-SPEED AUTO	3.21	11,900	6,720	6,460	6,620	6,410	6,580	6,390
	3.55	12,900	7,710	7,460	7,620	7,410	7,580	7,390
3.0L ECODIESEL V6/8-SPEED AUTO	3.21	13,900	8,370	8,160	8,210	8,010	8,250	7,850
	3.92	15,600	10,070	9,860	9,910	9,710	9,950	9,550
	3.92	18,200	12,560					
5.7L HEMI V8/8-SPEED AUTO	3.21	13,900	8,520	8,310	8,440	8,190	8,390	8,200
	3.92	17,000	11,620	11,410	11,540	11,290	11,490	11,300
5.7L HEMI V8 eTORQUE/8-SPEED AUTO	3.21	13,900	8,440	8,220	8,300	8,120	8,300	7,990
	3.92	17,000	11,540	11,320	11,400	11,220	11,400	11,090
	3.92	18,350	<b>12,750</b>					

Notes regarding the payload and towing charts above: numbers in **black boxes** reflect max ratings. 1. Payload and Max Trailer Weights are ESTIMATED values. 2. All weights are shown in pounds unless otherwise stated. 3. Payload and Max Trailer Weight values are rounded to the nearest 10 lb. 4. Payload = GCWR - Base Weight. 5. Trailer Weight Rating (TWR) and Tow Vehicle Trailing Weight are calculated as specified in SAE J2807. Passenger Weight = 300 lb. Options Weight is option content above 33 percent of sales volume. Trailer Equipment Weight = Class IV Hitch Receiver is 11.1 lb (if not already included in Options Weight). Trailer Hitch is 10 lb if TWR is less than or equal to 5,000 lb, and 65 lb if TWR is greater than 5,000 lb. 6. Payload and Trailer Weight Rating are mutually exclusive. 7. GAWRs, GVWRs and GCWRs should never be exceeded. 8. The recommended tongue weight for a conventional hitch is 10 percent of the gross trailer weight. The maximum tongue weight for Class IV hitch receiver is limited to 1,100 lb. 9. Weight-Distributing Hitch is recommended for trailers over 5,000 lb.

## RAM 1500 INTERIOR DIMENSIONS

All dimensions are in inches (millimeters) unless otherwise noted.		
	QUAD CAB	CREW CAB
<b>FRONT</b>		
HEAD ROOM	40.9 (1038)	40.9 (1038)
LEG ROOM	40.9 (1040)	40.9 (1040)
SHOULDER ROOM	66.0 (1676)	66.0 (1676)
HIP ROOM	63.4 (1610)	63.4 (1610)
SEAT TRAVEL	8.7 (220)	8.7 (220)
<b>REAR</b>		
HEAD ROOM	39.2 (995)	39.8 (1011)
LEG ROOM	35.6 (903)	45.2 (1147)
SHOULDER ROOM	65.7 (1668)	65.7 (1670)
HIP ROOM	63.4 (1610)	63.4 (1611)
<b>INTERIOR VOLUME</b>		
FRONT, cu ft (cu m)	63.9 (1.8)	63.9 (1.8)
REAR, cu ft (cu m)	53.3 (1.5)	68.5 (1.9)

## RAM 1500 CARGO BOX DIMENSIONS

All dimensions are in inches (millimeters) unless otherwise noted.		
BOX SIZE	5' 7"	6' 4"
SAE VOLUME, cu ft (cu m)	53.9 (1.5)	61.5 (1.7)
LENGTH AT FLOOR, TAILGATE CLOSED	67.4 (1711)	76.3 (1937)
CARGO WIDTH	66.4 (1687)	66.4 (1687)
DISTANCE BETWEEN WHEELHOUSINGS	51.0 (1295)	51.0 (1295)
DEPTH	21.4 (543)	21.5 (545)
TAILGATE OPENING WIDTH	60.0 (1525)	60.0 (1525)



# RAM OUTFITTER

DRIVE HOME THE POINT: YOU'RE TOTALLY INTO RAM TRUCKS.

**BORN UNDER THE RAM LOGO.** Drive a pickup with total street cred—and then take it to the next level. Ram Outfitter is where you'll find the useful, the cool and the stylish—from clothing and caps to coolers and tools. Make the Ram identity part of your everyday lifestyle. It's all at [RAMTRUCKS.COM/OUTFITTER](https://RAMTRUCKS.COM/OUTFITTER)



1 Class based on light-duty pickups. When properly equipped. See dealer for details. 2 Never operate the vehicle with the seats reclined to the extent that the seat belts are not secure and flat against your torso. 3 Requires compatible iPhone. See dealer for phone compatibility. Data plan rates apply. Vehicle user interface is a product of Apple. Apple CarPlay, Apple Music and Siri are trademarks of Apple Inc. iPhone is a trademark of Apple Inc., registered in the US and other countries. Apple terms of use and privacy statements apply. 4 When properly equipped. See dealer for details. 5 Always sit properly in designated seating positions with seat belts securely fastened at all times. 6 This system is a driver convenience system, not a substitute for active driver involvement. The driver must remain aware of traffic conditions and maintain control of the vehicle. 7 This system is a driver convenience system, not a substitute for active driver involvement. The driver must remain aware of traffic conditions and be prepared to use the brakes to avoid collisions. 8 This system is an alert system for the front of the vehicle. It is not a substitute for active driver involvement. The driver must remain aware of traffic conditions and be prepared to use the brakes to avoid collisions. 9 Always check visually for vehicles prior to changing lanes. 10 Always check entire surroundings visually before proceeding. 11 Assumes properly equipped vehicle and 150-lb allowance for driver. Additional options, equipment, passengers and cargo weight must be subtracted. See dealer for details. 12 Visit Mopar.com for complete details and a copy of the Powertrain Limited Warranty. 13 Class based on light-duty pickups and EPA-estimated 19 mpg combined with 5.7L eTorque engine. Actual mileage may vary. 14 Based on EPA-estimated 22 mpg hwy on Ram 1500 with 5.7L V8 eTorque engine and standard 26-gallon fuel tank. Actual mileage may vary. 15 Class based on light-duty pickups and EPA-estimated fuel economy of 23 mpg. 16 Based on EPA-estimated 24 mpg hwy on Ram 1500 with 3.6L V6 eTorque engine and standard 26-gallon fuel tank. Actual mileage may vary. 17 Check state and local laws regarding the use of remote start systems. 18 SiriusXM Radio, SiriusXM Traffic Plus and SiriusXM Travel Link each require a subscription, sold separately or as a package, by SiriusXM Radio Inc. If you decide to continue service after your 1-year/5-year trial included with the new vehicle purchase, the subscription plan you choose will automatically renew thereafter and you will be charged according to your chosen payment method at then-current rates. Trial service is not transferable. Fees and taxes apply. Please see the Customer Agreement at www.siriusxm.com for complete terms and how to cancel, which includes calling SiriusXM at 1-866-635-2349. All fees and programming are subject to change. Not all vehicles or devices are capable of receiving all services offered by SiriusXM. Data displays and individual product availability vary by vehicle hardware. Current information and features may not be available in all locations, or on all receivers. Weather Forecast, Current Conditions may not be available in all locations. 19 To use Android Auto on your phone screen, you'll need an Android phone running 5.0 or higher and the Android Auto App. Google, Android, Google Play and Android Auto are trademarks of Google LLC. 20 All SiriusXM Guardian equipped vehicles come with a 12-month trial effective on the date of purchase or lease of a new vehicle. Enrollment in the trial is required to receive service. Upon expiration of the trial period, purchase of a subscription is required to continue SiriusXM Guardian. SiriusXM Guardian is available only on equipped vehicles purchased within the United States and Puerto Rico. Services can only be used where cellular coverage is available. See Uconnect and SiriusXM Guardian Terms of Service for complete service limitations. 21 This feature does not work while the vehicle is in motion. 22 Three-month/1GB trial included with the purchase or lease of a new vehicle. Upon expiration of the trial period, purchase of a subscription is required. WiFi Hotspot available through third-party subscription. Requires Internet-enabled mobile device. See dealer for details. This feature is not intended for use by the driver while the vehicle is in motion. Always drive carefully. 23 The Uconnect Phone requires a mobile phone equipped with the Bluetooth Hands-Free Profile. To check phone compatibility, please visit www.UconnectPhone.com. 24 Voice Text Reply feature requires a compatible mobile device that supports text messaging and Bluetooth. Visit www.UconnectPhone.com for system and device compatibility. 25 Requires an iPhone with Siri. Certain features are not available while the vehicle is in motion. iPhone must be within active cellular range. Customer's existing iPhone data rates apply to Internet-supported features. 26 Remote Vehicle Start is not available on all vehicles. You are responsible for using remote features in accordance with any laws, rules or ordinances in effect in your vehicle's location. You must have an active subscription to SiriusXM Guardian in order to use remote services. See Terms of Service for service limitations. 27 Based on Ram 1500 Limited/Laramie Longhorn standard premium content comparison to Ford F-150 Platinum, Chevy Silverado 1500 High Country, GMC Sierra 1500 Denali, Toyota Tundra, and Nissan Titan Standard Full-Size Pickups. 28 Lone Star model available only in Texas. 29 Mopar Performance Parts, including Lift Kits, are designated as "Off-Road Only" parts and have not been evaluated or tested for crashworthiness or compliance with safety standards. Mopar Parts noted as "Off-Road Only" are aftermarket only and may not be installed by a Chrysler, Dodge, Jeep, Ram or FIAT dealer on a new vehicle, and may not be sold or financed in conjunction with the sale of a new vehicle. FCA US LLC does not authorize the installation of any part noted as "Off-Road Only" on any vehicle prior to its first retail sale. 30 Always drive carefully, consistent with conditions. Always wear your seat belt and obey traffic laws. 31 Always look before proceeding. An electronic drive aid is not a substitute for conscientious driving. Always be aware of your surroundings. 32 Always sit properly with the head restraint properly adjusted. Never place anything in front of the head restraint. 33 Always drive carefully, consistent with conditions. 34 Vehicle must be locked and system activated for alarm to sound.

©2019 FCA US LLC. All Rights Reserved. Ram, Mopar, the Ram's Head logo, Big Horn, HEMI, LaneSense, Laramie, Laramie Longhorn, Pentastar, ParkSense, ParkView, Quad Cab, RamBox, Rebel, Sentry Key, Tradesman and Uconnect are registered trademarks, and Active-Level, Built to Serve, HFE High Fuel Efficiency & Design and Keyless Enter 'n Go are trademarks of FCA US LLC.

Bilstein is a registered trademark of August-Bilstein GmbH & Co. Harman Kardon is a registered trademark of Harman International Industries, Inc. SiriusXM Connected Vehicles Services Inc., Sirius, XM, SiriusXM and SiriusXM Guardian and all related marks and logos are trademarks of Sirius XM Radio Inc. Bluetooth is a registered trademark of Bluetooth SIG, Inc. Facebook and logo are registered trademarks of Facebook, Inc. The Twitter logo is a service mark of Twitter, Inc. Instagram and logo are registered trademarks of Instagram, Inc. Alpine is a registered trademark of Alpine Electronics, Inc. Airstream is a registered trademark of Airstream Inc. All rights reserved. SmartBeam is a registered trademark of Gentex Corporation. WhatsApp is a registered trademark of WhatsApp Inc. Spotify is a registered trademark of Spotify AB. Audible is a registered trademark of Audible, Inc. Pandora is a registered trademark of Pandora Media, LLC.

About this catalog: since the time of publication, some of the information you'll find in this catalog may have been updated. Ask your dealer for details. Some of the equipment shown or described throughout this catalog may be available at extra cost. Specifications, descriptions, illustrative materials and all competitive comparisons contained herein are as accurate as known at the time this publication was approved for printing. FCA US LLC reserves the right to discontinue models at any time or change specifications without notice or without incurring obligation. Options may be required in combination with other options. For the price of the model with the equipment you desire, or verification of specifications contained here, see your Ram dealer.

JOIN IN



Join fellow Ram enthusiasts and tell your story by posting comments, participating in discussions, and sharing your photos and videos. Join our community on Facebook, Twitter, YouTube and Instagram.

Explore Ram Life  
[ramtrucks.com/ram-life.html](http://ramtrucks.com/ram-life.html)

RAMTRUCKS.COM

Ram is a registered trademark of FCA US LLC.

74-383-2017\_1/20